

WINDOW

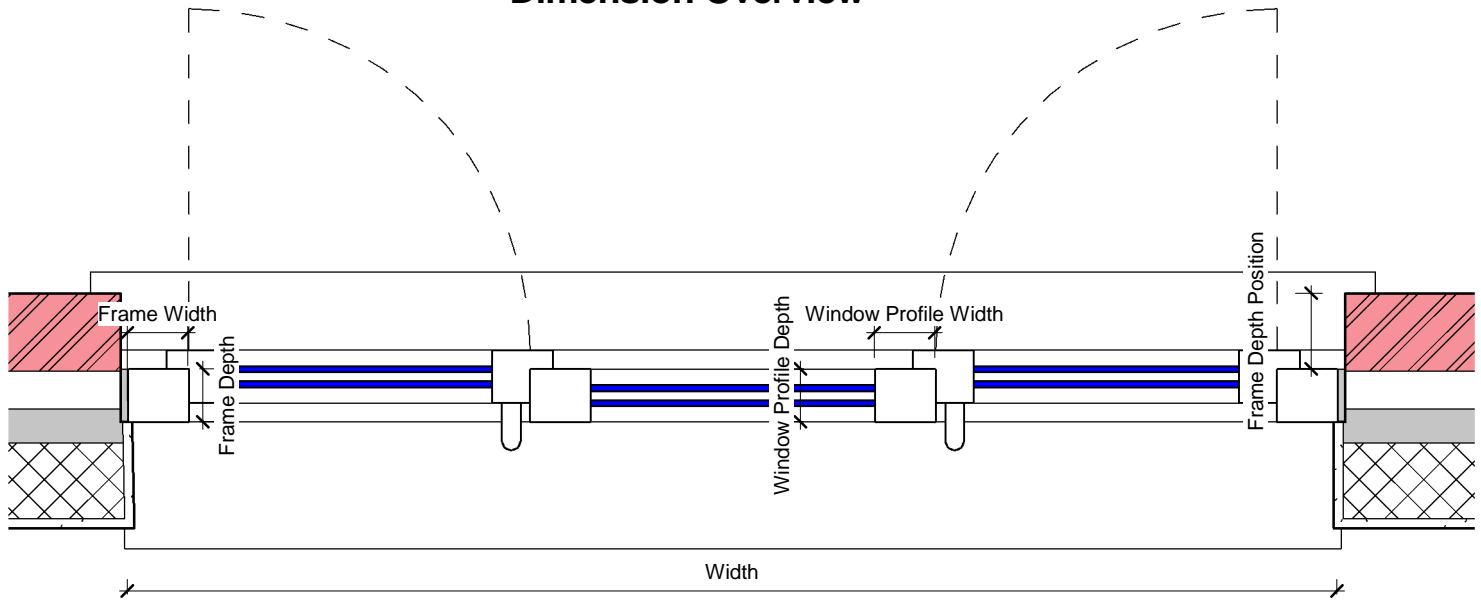

Dimension Overview



GENERAL PLAN DIMENSIONS

FIG 1

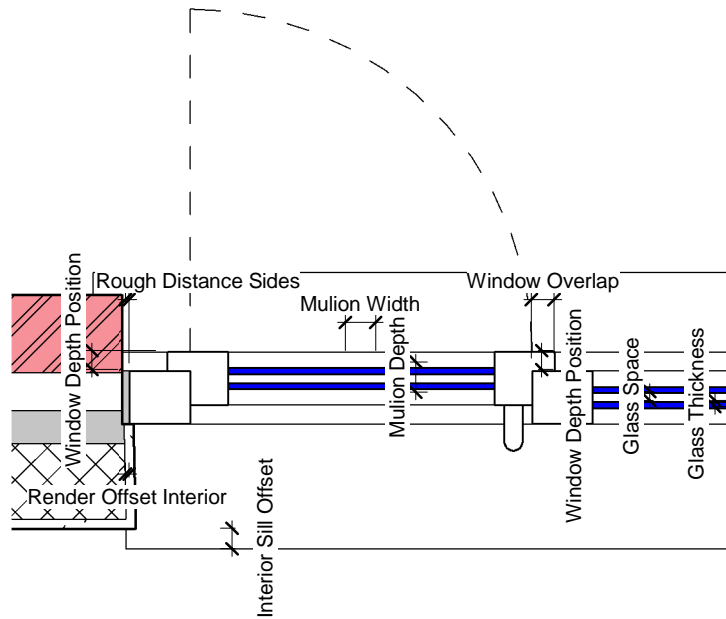

DETAIL PLAN DIMENSIONS

FIG 2

Dimension Overview

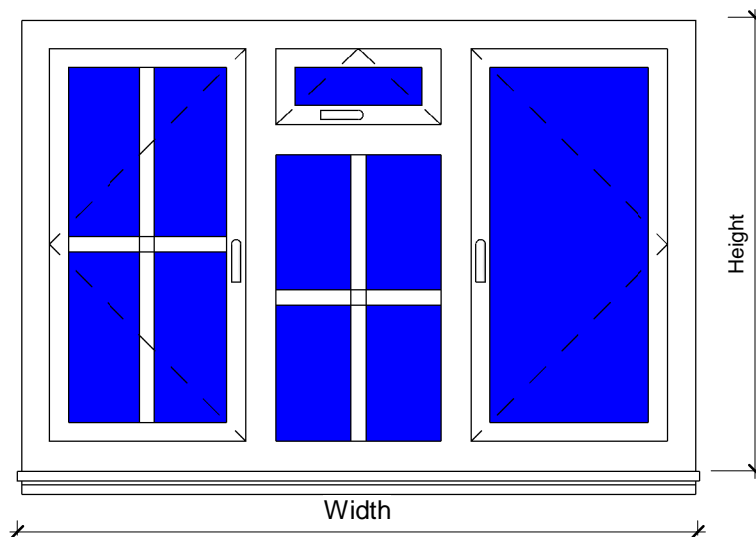

GENERAL ELEVATION DIMENSIONS

FIG 3

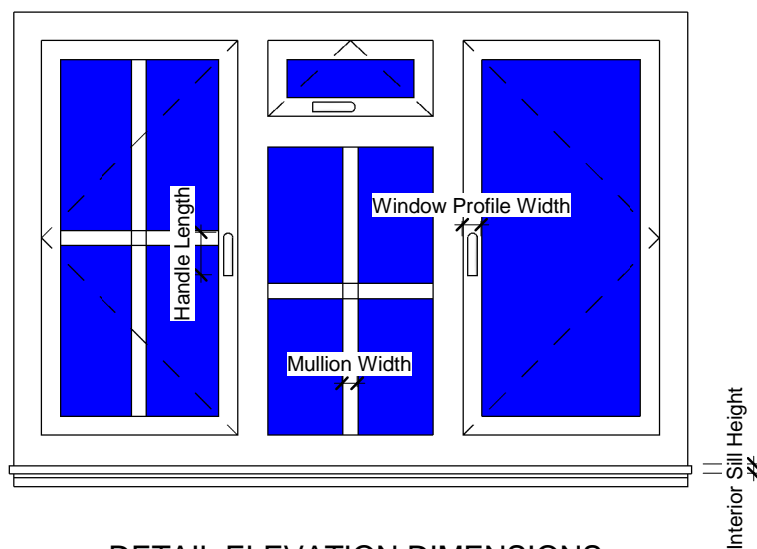

DETAIL ELEVATION DIMENSIONS

FIG 4

Dimension Overview

DETAIL SECTION

FIG 5

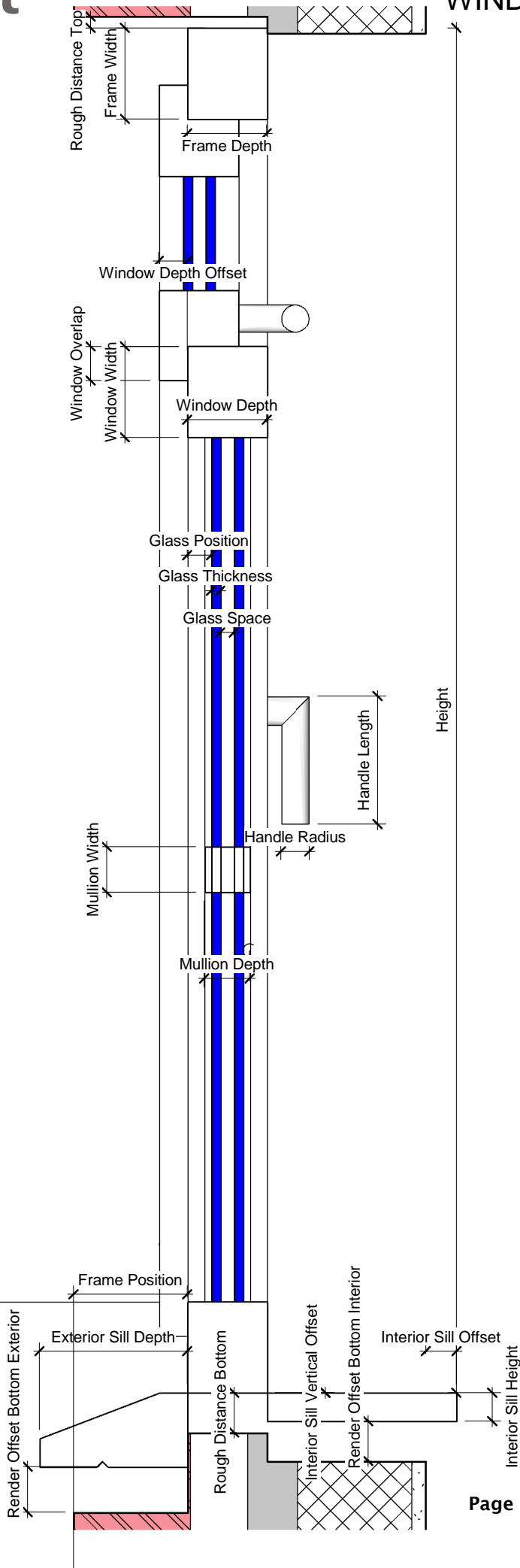

VERTICAL SETUP

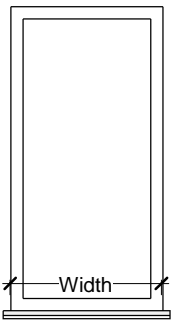

W1	W2	W3	W4	W5
Visibility				
<input type="checkbox"/>	<input type="checkbox"/>	<input type="checkbox"/>	<input type="checkbox"/>	<input type="checkbox"/>
Height %				
0	0	0	0	0
Width %				
0	0	0	0	0
Position Horizontal				
0	0	0	0	0
Position Vertical				
0	0	0	0	0
Offset Horizontal				
0	0	0	0	0
Offset Vertical				
0	0	0	0	0

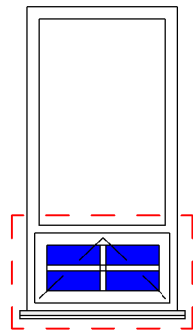

W1

(1) Visibility	<input checked="" type="checkbox"/>
(2) Height %	25
(3) Width %	100
(4) Position Horizontal	0
(5) Position Vertical	0
(6) Offset Horizontal	0
(7) Offset Vertical	0

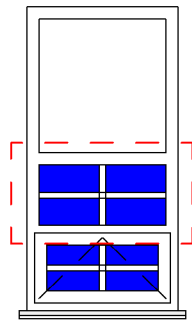

W2

(1) Visibility	<input checked="" type="checkbox"/>
(2) Height %	25
(3) Width %	100
(4) Position Horizontal	0
(5) Position Vertical	0
(6) Offset Horizontal	0
(7) Offset Vertical	25

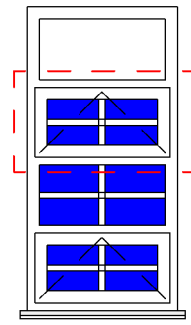

W3

(1) Visibility	<input checked="" type="checkbox"/>
(2) Height %	25
(3) Width %	100
(4) Position Horizontal	0
(5) Position Vertical	1
(6) Offset Horizontal	0
(7) Offset Vertical	25

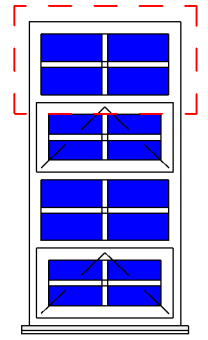

W4

(1) Visibility	<input checked="" type="checkbox"/>
(2) Height %	25
(3) Width %	100
(4) Position Horizontal	0
(5) Position Vertical	1
(6) Offset Horizontal	0
(7) Offset Vertical	0

HORIZONTAL SETUP

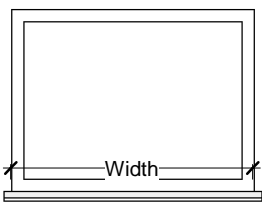

W1	W2	W3	W4	W5
Visibility				
<input type="checkbox"/>	<input type="checkbox"/>	<input type="checkbox"/>	<input type="checkbox"/>	<input type="checkbox"/>
Height %				
0	0	0	0	0
Width %				
0	0	0	0	0
Position Horizontal				
0	0	0	0	0
Position Vertical				
0	0	0	0	0
Offset Horizontal				
0	0	0	0	0
Offset Vertical				
0	0	0	0	0

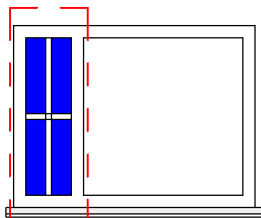

W1

(1) Visibility	<input checked="" type="checkbox"/>
(2) Height %	100
(3) Width %	25
(4) Position Horizontal	0
(5) Position Vertical	0
(6) Offset Horizontal	0
(7) Offset Vertical	0

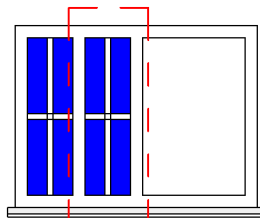

W2

(1) Visibility	<input checked="" type="checkbox"/>
(2) Height %	100
(3) Width %	25
(4) Position Horizontal	0
(5) Position Vertical	0
(6) Offset Horizontal	0
(7) Offset Vertical	25

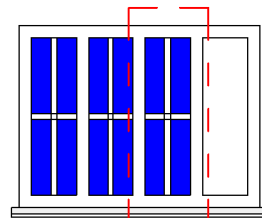

W3

(1) Visibility	<input checked="" type="checkbox"/>
(2) Height %	100
(3) Width %	25
(4) Position Horizontal	1
(5) Position Vertical	0
(6) Offset Horizontal	0
(7) Offset Vertical	25

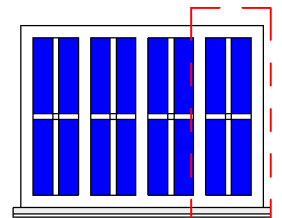

W4

(1) Visibility	<input checked="" type="checkbox"/>
(2) Height %	100
(3) Width %	25
(4) Position Horizontal	1
(5) Position Vertical	0
(6) Offset Horizontal	0
(7) Offset Vertical	0

See Page 5 of 5 For Window Parameter Overviews

Window Parameter Overviews

Visibility

This Parameter controls each window visibility for the fix or swing window.

There are 5 windows in (RFAM2310_Window - 5) and 10 windows in (RFAM2310_Window - 10).

Single or Multiple Windows can be switched on or off. See Page 4 of 5 Vertical Setup & Horizontal Setup.

This shows each stage of the window visibility and the setup. Once visibility is switched on, the parameters as explained below and shown on Page 4 of 5 needs to be adjusted for the correct position and proportion.

Height %

This Parameter controls the Height in percentage. See Page 4 of 5 Vertical Setup & Horizontal Setup.

To achieve a result of 4 windows as shown, W1 Height%,W2 Height%,W3 Height% and W4 Height% are set at

25% of the Height for the Vertical Setup and 100% of the Height for the Horizontal Setup. Once Height % parameters on each window are adjusted and the required window visibilities are switched on, the next steps are explained below and shown on Page 4 of 5 that need to be adjusted for the correct position and proportion.

Width%

This Parameter controls the Width in percentage. See Page 4 of 5 Vertical Setup and Horizontal Setup.

To achieve a result of 4 windows as shown, W1 Height%,W2 Height%,W3 Height% and W4 Height% are set at

100% of the Height for the Vertical Setup and 25% of the Height for the Horizontal Setup. Once Width % and Height % parameters on each window are adjusted and the required window visibilities are switched on, the next steps are explained below and shown on Page 4 of 5 that need to be adjusted for the correct position and proportion.

Position Horizontal

This Parameter controls the Horizontal position of each window. This is an integer parameter which only uses the value 0 and 1. If the value is set to 0, the window Width and the Horizontal offset is adjusted and positioned from the Left. If the value is set to 1, the window Width and the Horizontal offset is adjusted and positioned from the Right.

See Page 4 of 5 Vertical Setup & Horizontal Setup. In the Horizontal Setup, W1 Position Horizontal is set to 0 which means the Width and the Horizontal position is adjusted from the Left. In the Horizontal Setup W4 Position is set to 1 which means the Width and the Horizontal position is adjusted from the Right.

Note: The Vertical Setup is set to 0.

Position Vertical

This Parameter controls the Vertical position of each window. This is an integer parameter which only uses the value 0 and 1. If the value is set to 0, the window Height & the Vertical offset is adjusted and positioned from the Bottom. If the value is set to 1, the window Height and the Vertical offset is adjusted and positioned from the Top.

See Page 4 of 5 Vertical Setup and Horizontal Setup. In the Vertical Setup, W1 Position Vertical is set to 0 which means the Height and the Vertical position is adjusted from the Bottom. In the Vertical Setup W4 Position is set to 1 which means the Height and the Vertical position is adjusted from the Top.

Note: The Horizontal Setup is set to 0.

Offset Horizontal

This Parameter controls the Horizontal offset of each window. This is a percentage parameter similar to the Height% and Width%. See Page 4 of 5 Vertical Setup and Horizontal Setup. Width% values for the Horizontal Setup are set to 25%, W2 Offset Horizontal is positioned from the Left, and W3 Offset Horizontal is positioned from the Right;

simply add the same value as the Width%. The W2 window offsets from W1 and sits at the side of W1 window, and the W3 window sits at the side of W4. If this value is 0 the windows W2 and W3 will overlap W1 and W4

Note: The Vertical Setup is set to 0.

Offset Vertical

This Parameter controls the Vertical offset of each window. This is a percentage parameter similar to the Height% and Width%. See Page 4 of 5 Vertical Setup and Horizontal Setup. Width% values for the Vertical Setup are set to 25%, W2 Offset Vertical is positioned from the Bottom, and W3 Offset Horizontal is positioned from the Top; simply add the same value as the Height%.

The W2 window offsets from W1 and sits at the Top of W1 window, and the W3 window sits at the Bottom of W4. If this value is 0 the windows W2 and W3 will overlap W1 and W4

Note: The Vertical Setup is set to 0.

OPENING SWINGS

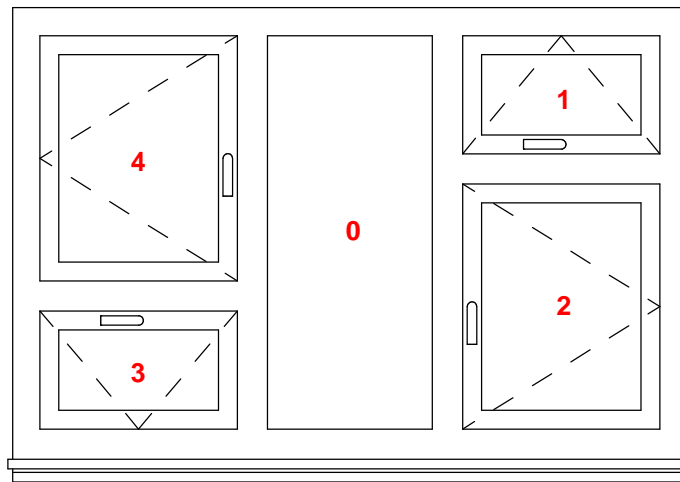

Opening Swing

This Parameter controls each fix or swing window.

- 0** FIX
- 1** TOP
- 2** LEFT
- 3** BOTTOM
- 4** RIGHT
- 12** TOP RIGHT
- 32** BOTTOM RIGHT
- 34** BOTTOM LEFT
- 14** TOP LEFT

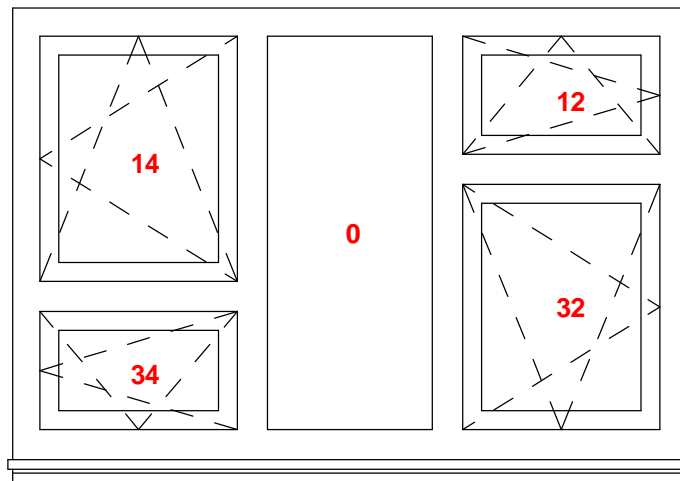

DETAILS OF SYMBOL LINES

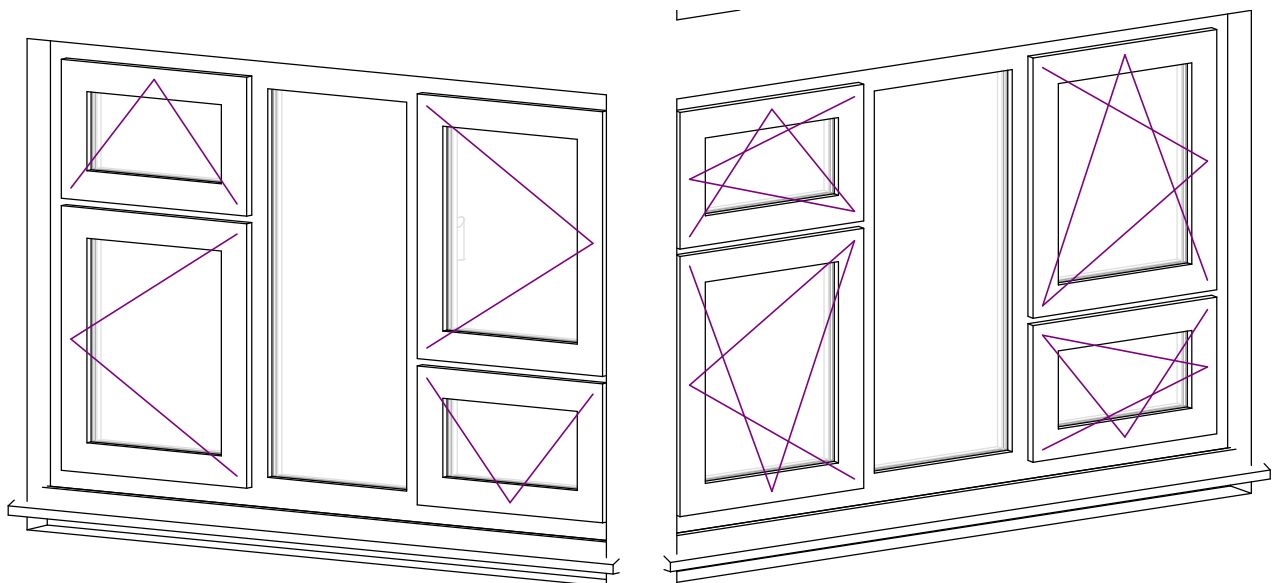

MITERED FRAMES

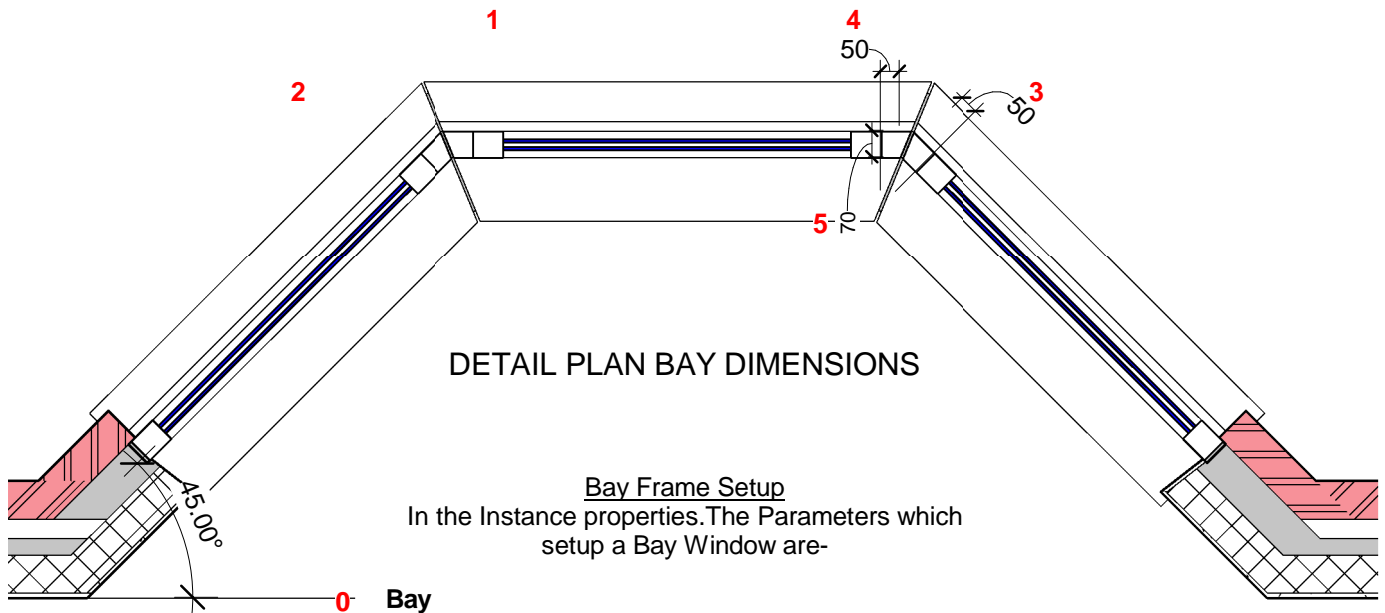

DETAIL PLAN BAY DIMENSIONS

Bay Frame Setup

In the Instance properties. The Parameters which setup a Bay Window are-

- 0 Bay**
This is a main Parameter which activates or deactivates the bay window functionality. If this parameter is activated, the frame will miter according to the values set in the instance parameters. If deactivated, the miters will set to a standard frame with zero degrees angle
- 1 Bay Frame Miter Left Angle**
Controls the angle of the Left mitered edge when the Bay parameter is activated
- 2 Bay Frame Miter Right Angle**
Controls the angle of the Right mitered edge when the Bay parameter is activated
- 3 Bay Frame Left Interior Post Width**
Controls the width of the left interior mitered edge when the Bay parameter is activated
- 4 Bay Frame Right Interior Post Width**
Controls the width of the right interior mitered edge when the Bay parameter is activated
- 5 Bay Frame Post Depth**
Controls the depth of the left and right mitered post when the Bay parameter is activated

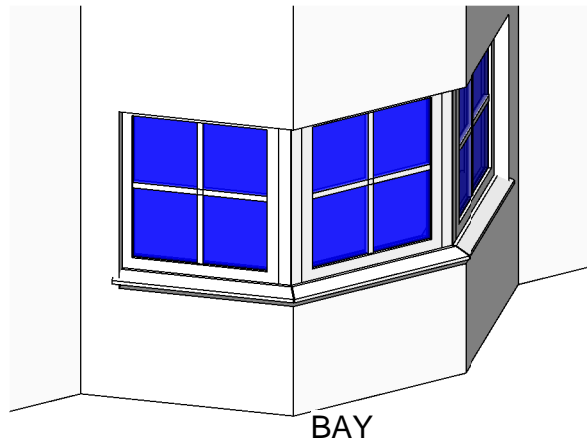

WINDOW TRIM

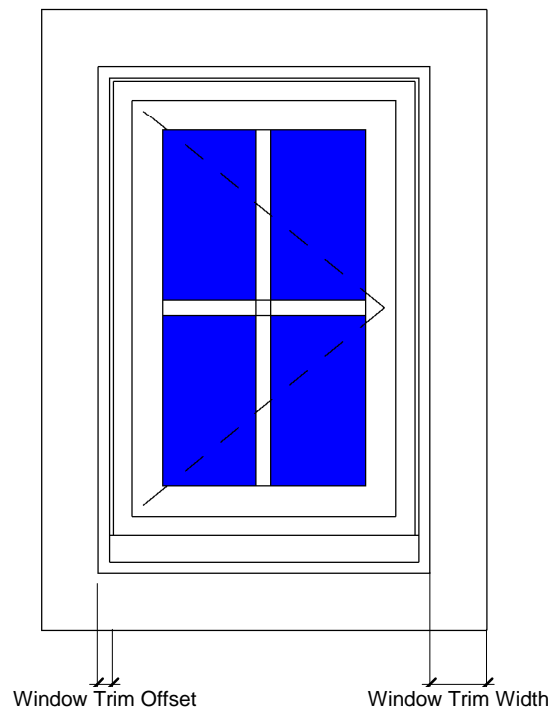
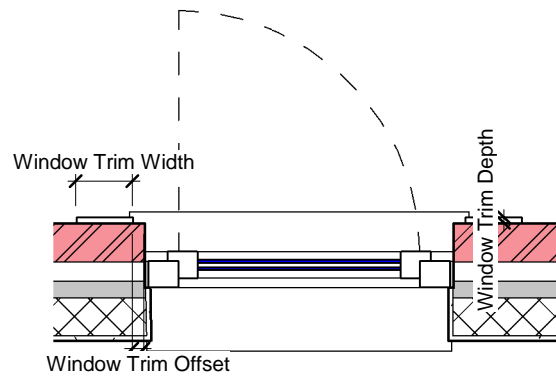
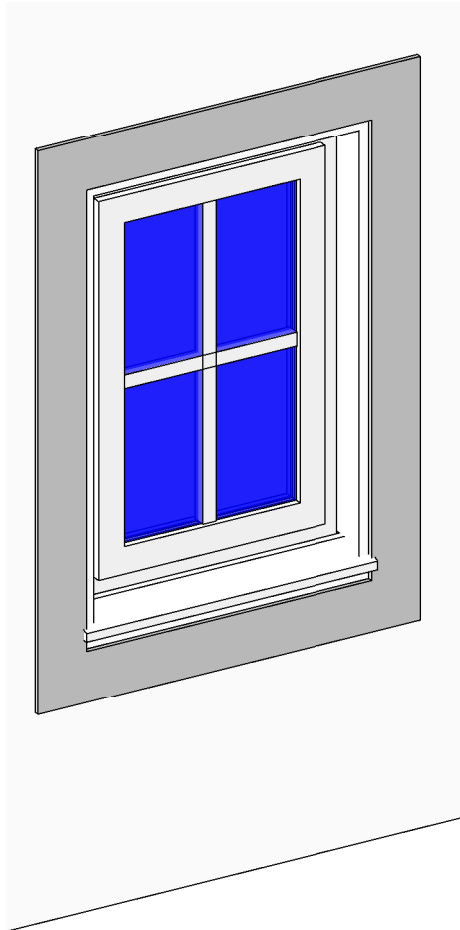

In the Instance properties. The Parameter which activates the window trim is "Window Trim Visibility". To adjust the trim in its width and thickness, you can adjust the parameters which are:-
 Window Trim Width
 Window Trim Depth
 Window Trim Offset

These parameters can also be found in the instance parameters under Dimensions

LOUVERS

In the type properties under Graphics each window has a set of parameters which adjust the Louvers,

Louver Visibility = Checkbox under the Graphics Menu in Type Properties.

Once selected, this will show louvers as shown in the images below. Please note to adjust the Louver Count adjust the parameter "Mullion horizontal count".

if "Louver Visibility" is unselected this will show horizontal mullions if the count is more than zero.

Louver Count = Checkbox under the Graphics Menu in Type Properties.

If "Louver Count" is Selected this will show Horizontal Louvers if the count is more than zero.

These Louvers lengths automatically adjust in the length when the "Mullion horizontal count" is adjusted more than zero

If "Louver Count" is Unselected you will be able to adjust the "Louver Length" and the Louver Count will be adjusted automatically

Louver Length = Length under the Dimensions Menu in Type Properties.

As explained in the Louver Count above if the Louver Count Checkbox is unselected then the Louver Length can be adjusted so each louver has a specified height. The louver count is automatically adjusted. This is a general parameter which adjusts all louver lengths if the Louver count checkbox is unselected.

If the Louver count checkbox is selected then please note the louver length & count will not flex

Louver Thickness = Length under the Dimensions Menu in Type Properties.

This is a general parameter which adjusts all louver thickness if Louver Visibility is activated

Louver Offset = Length under the Dimensions Menu in Type Properties.

This is a general parameter which adjusts all louver offset if Louver Visibility is activated

Louver Angle = Angle under the Dimensions Menu in Instance Properties.

"Louver Angle" parameter allows you to adjust the angle of the Louvers in each window setup

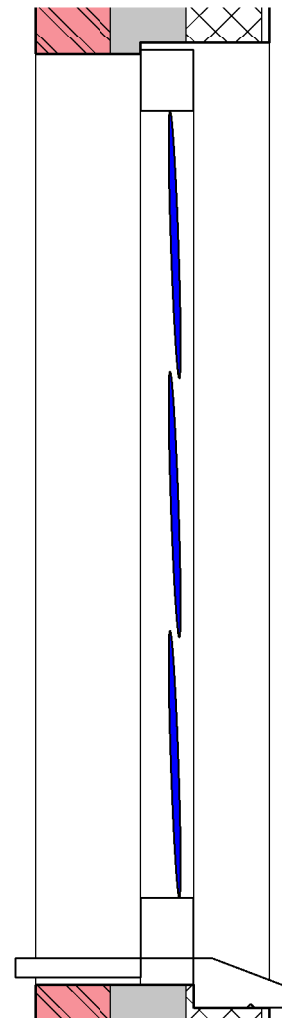
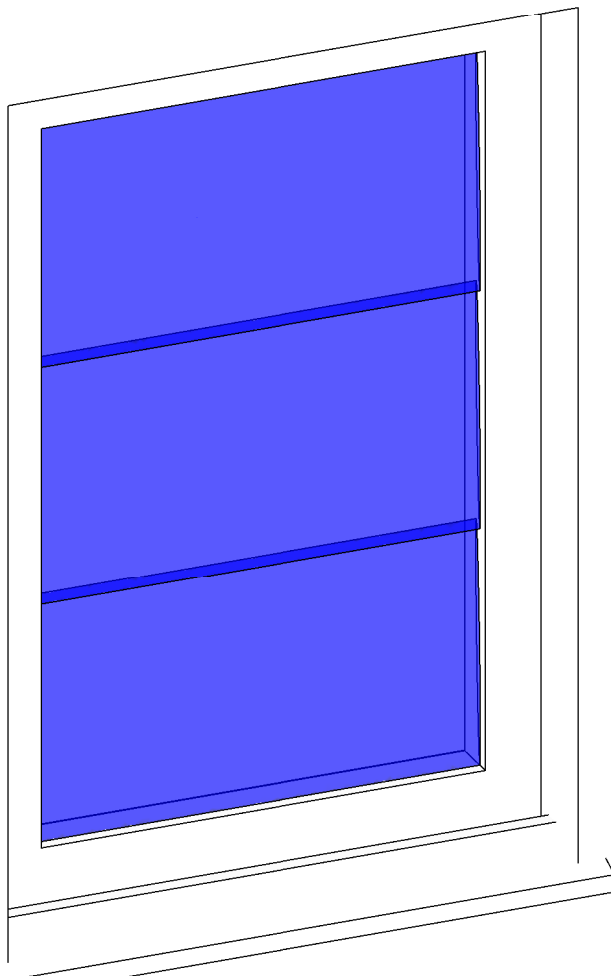

SINGLE DOUBLE GLAZING

In the type properties under Constraints adjust the parameter
Glass Visibility which is a Integer/Number Parameter.
The Results are shown below.
If the parameter is set to 0, then the glass visibility will switch off

Glass Visibility = 1

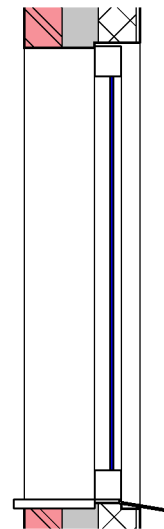
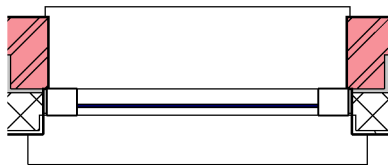

Glass Visibility = 2

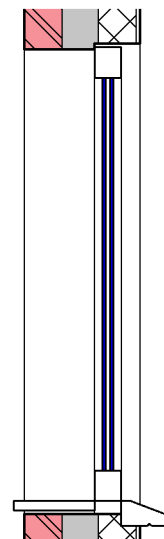
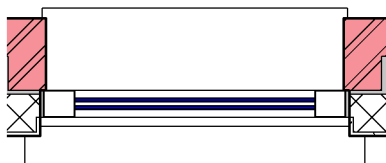

SILLS

In the type properties under Constraints adjust the parameter
Exterior Sill Visibility which is a Integer/Number Parameter.
The Results are shown below.
If the parameter is set to 0, then the sill visibility will switch off

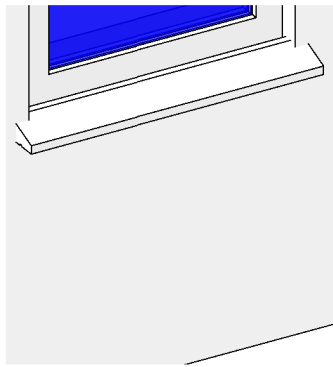

**Exterior Sill Visibility = 1
Stone Sill**

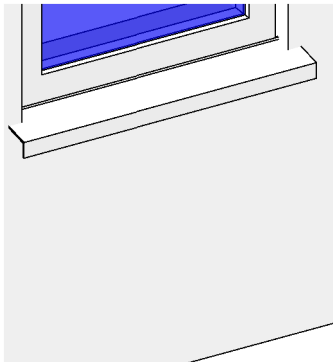

**Exterior Sill Visibility = 2
Aluminium Sill**

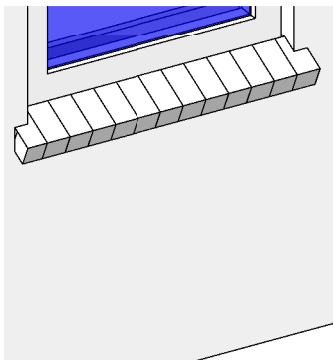

**Exterior Sill Visibility = 3
Brick Sill**

Plan View Graphics (From Version 1.5)

Our All In One Window consists of several nested panes, (5 or 10) depending on which file you use and as these panes are parametrically positionable, the standard Revit cutplane would not always show the window correct in plan view.

As a solution for this issue the All In One Window has a built in parameter for each pane to allow the user to control which panes shall be shown in the plan view.

This parameter (Wx PLAN SYMBOL LINE VISIBILITY) for each pane can be found in the type parameters next to the Window Visibility Parameters