

PLAN

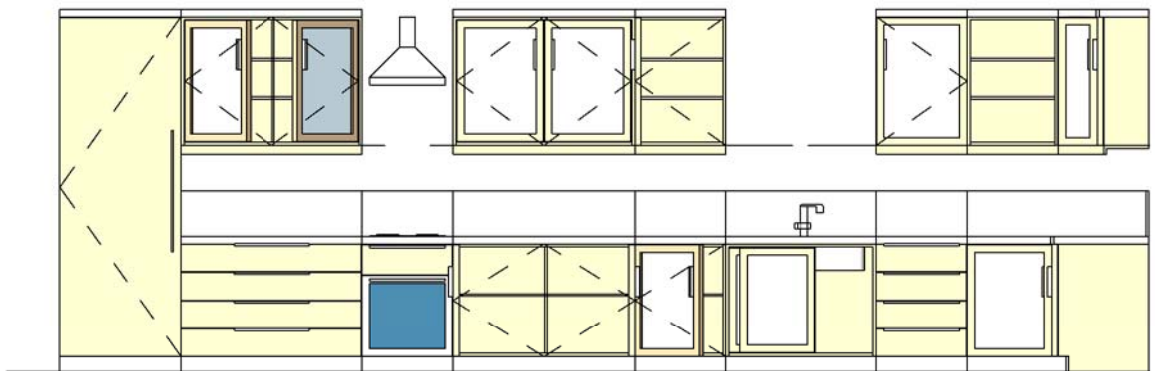

FRONT ELEVATION

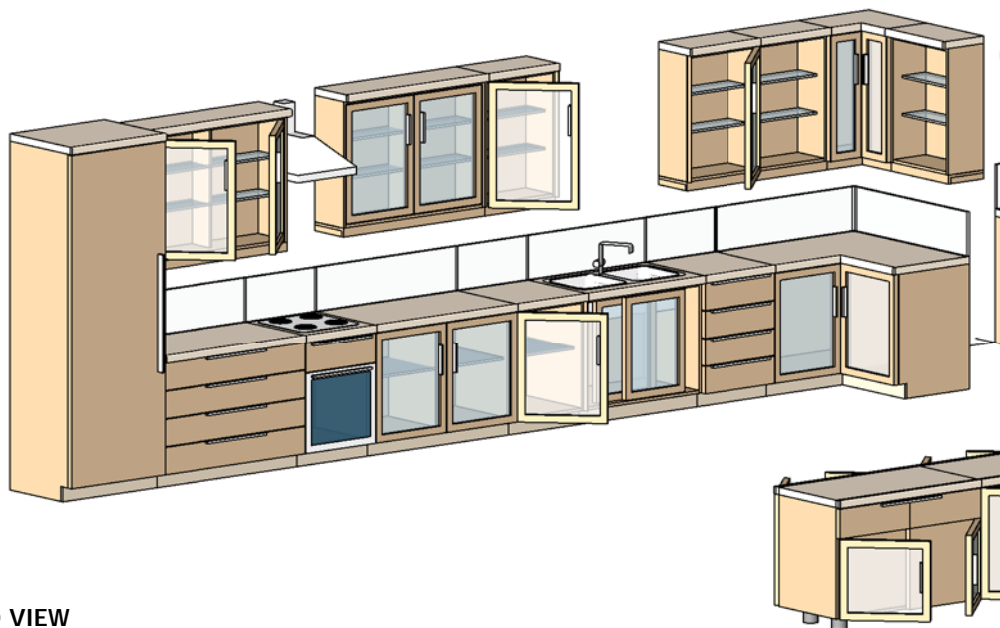

3D VIEW

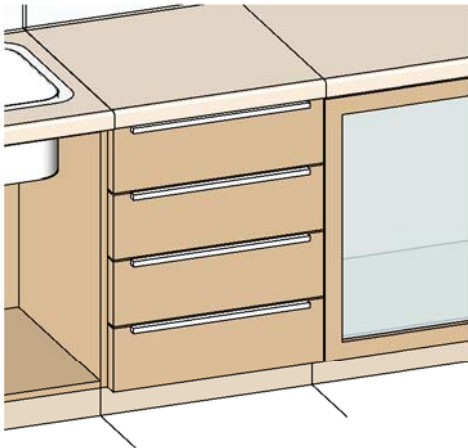

FIG 1

How To Create Drawers

In the Type Parameters under:-

Graphics

The tick boxes that need to be selected are:-
OUTER FRAME VISIBILITY, TOP VISIBILITY & JUST DRAWERS
The result is shown in Fig 1
A choice to have the Drawers in the the outerframe flushed or the exterior of the outerframe just by selecting the **PANEL BETWEEN**

Dimensions

Adjust the Height to 900mm And the Width to 1000mm
You can specify and control the Drawers & The Drawer Handle.
The Parameters which can be adjusted to change the Drawers are :-
DRAW COUNT which adjust the amount of draws you may want to specify
DRAW HEIGHT, DRAW HANDLE POSITION, DRAW HANDLE THICKNESS, DRAW HANDLE WIDTH & LENGTH.
(PLEASE REFER TO DIMENSIONS OVERVIEW)

No Drawers

For no Drawers set **DRAW COUNT** to zero.

How To Create Floor Unit Double & Single

In the Type Parameters under:-

Graphics

The tick boxes that need to be selected are:-
OUTER FRAME VISIBILITY, TOP VISIBILITY, DOORS VISIBILITY, DOOR HANDLE VISIBILITY & DOUBLE SWING
The result is shown in Fig 2
A choice to have the Doors in the the outerframe flushed or the exterior of the outerframe just by selecting the **PANEL BETWEEN**

If the Tick Box **DOUBLE SWING** is:-
selected, The Result is shown as a Double Swing Unit
unselected, The Result is shown as a Single Swing Unit

Dimensions

You can specify and control the Door & The Door Handle.
The Parameters which can be adjusted to change the Doors are :-
WIDTH which adjust the panel widths when its a double or a single cupboard.
DOOR HANDLE POSITION, DOOR HANDLE THICKNESS, DOOR HANDLE WIDTH & LENGTH.
To Open & Close the doors, both doors have a swing parameter which are:-
DOOR OPENING LEFT & SINGLEX & DOOR OPENING RIGHTS.

This parameter **DOOR OPENING LEFT & SINGLEX** is for the left door. When you untick **DOUBLE SWING** the result is a Left single swing door which this parameter is used for. To create a Right single swing door, there is a flip control switch as shown in plan. This will flip the cupboard to give a result of a Right single swing door which the same parameter is used to open and close the swing door.

(PLEASE REFER TO DIMENSIONS OVERVIEW)

How To Create Floor Oven & Cooker Unit

In the Type Parameters under:-

Graphics

The tick boxes that need to be selected are:-
OUTER FRAME VISIBILITY, DOORS VISIBILITY, TOP VISIBILITY, COOKER VISIBILITY & OVEN VISIBILITY
The result is shown in Fig 3
A choice to have the Oven Door in the the outerframe flushed or the exterior of the outerframe just by selecting the **PANEL BETWEEN**

If the Tick Box **COOKER & OVEN** is:-
selected, The Result is shown as Fig 3
If Tick boxes are unselected, The Result is shown as Plain Worktop with no doors & Drawers

Dimensions

The Parameters which can be adjusted to change the Cooker are :-
COOKER WIDTH, COOKER DEPTH, COOKER BURNER THICKNESS, COOKER OFFSET, COOKER BURNER OFFSET FROM SIDE, COOKER BURNER FRONT & BACK OFFSET, COOKER BURNER WIDTH, COOKER BURNER DEPTH & COOKER BURNER RADIUS.
All these parameters adjust properly when its a double unit.
The Oven Unit adjusts with the Width & Height and with the **DRAW COUNT** as shown in Fig 5

The Results of changing the values of these parameters are shown on Page 10 of 14 from Fig 11 to 16

(PLEASE REFER TO DIMENSIONS OVERVIEW)

How To Create Floor Sink Unit

In the Type Parameters under:-

Graphics

The tick boxes that need to be selected are:-
OUTER FRAME VISIBILITY, TOP VISIBILITY, DOORS VISIBILITY, DRAINER VISIBILITY, SINK VISIBILITY SINK 2 VISIBILITY
The result is shown in Fig 4

Dimensions

Adjust the Height to 900mm And the Width to 1000mm
The Parameters which can be adjusted to change the Sink & Sink 2 are :-
SINK HEIGHT, SINK DEPTH, SINK WIDTH, SINK RADIUS, SINK SHELL THICKNESS, SINK POSITION FROM THE MIDDLE & SINK FRONT & BACK OFFSET

SINK 2 HEIGHT, SINK 2 DEPTH, SINK 2 WIDTH, SINK 2 RADIUS, SINK SHELL THICKNESS, SINK POSITION FROM SINK

SINK DRAINER LEFT OFFSET, SINK DRAINER RIGHT OFFSET, SINK DRAINER FRONT OFFSET & SINK DRAINER BACK OFFSET

SINK TAP HEIGHT, SINK TAP LENGTH, SINK TAP LENGTH 2, SINK TAP RADIUS, SINK TAP PROFILE WIDTH, SINK TAP PROFILE LENGTH, SINK TAP PROFILE RADIUS, SINK TAP POSITION FROM BACK, SINK TAP POSITION FROM SIDE

SINK TAP KNOB WIDTH, SINK TAP KNOB DEPTH, SINK TAP KNOB RADIUS, SINK TAP KNOB HEIGHT
(PLEASE REFER TO DIMENSIONS OVERVIEW)

The Results of changing the values of these parameters are shown on Page 11 of 14 from Fig 17 to 21

(PLEASE REFER TO DIMENSIONS OVERVIEW)

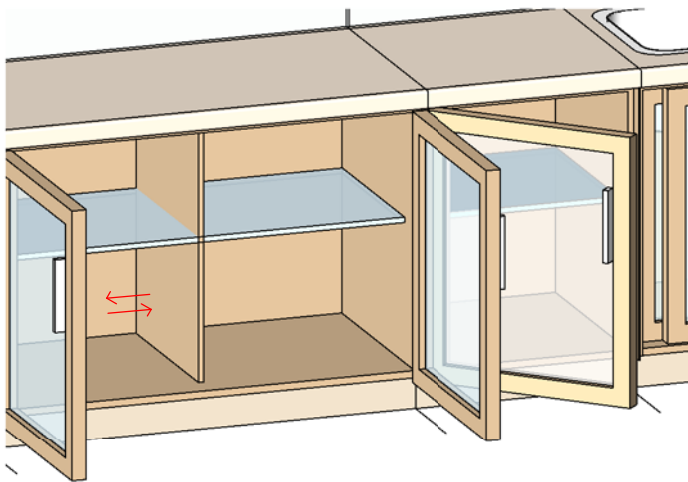

FIG 2

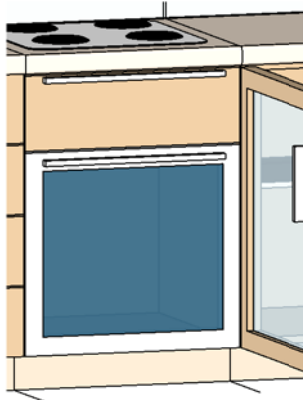

FIG 3

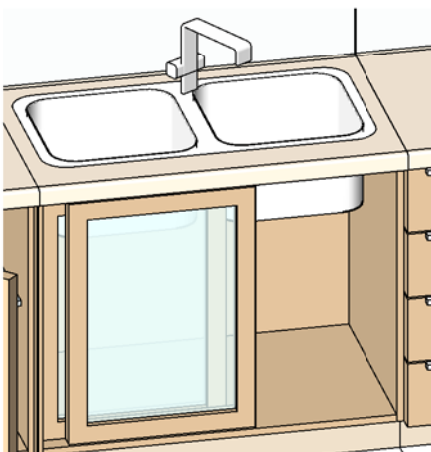

FIG 4

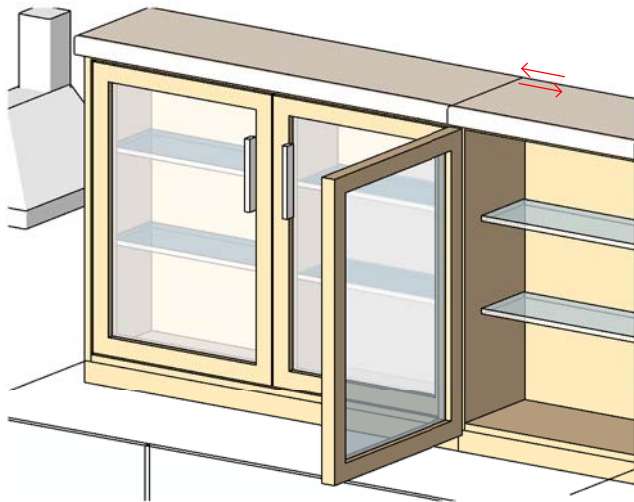

FIG 5

How To Create Wall Hung Double & Single Unit

In the Type Parameters under:-

Graphics

To Create the Wall hung unit, The process is the same as creating the floor units as described on page 1 - 5 under *How To Create Floor Unit Double & Single*. The parameter that needs to be adjusted is *WALL UNIT HEIGHT* which controls & switches the visibility on of all profiles, as shown in Fig 5

Dimensions

All parameters which are used to control the floor unit cupboard as described on page 1 of 5 are also used for the wall hung unit.
The additional Parameters which can be adjusted to change the Wall Unit are :-

WALL UNIT HEIGHT, WALL UNIT BOTTOM THICKNESS, WALL UNIT FRONT BOTTOM LENGTH & WALL UNIT FRONT THICKNESS

(PLEASE REFER TO DIMENSIONS OVERVIEW)

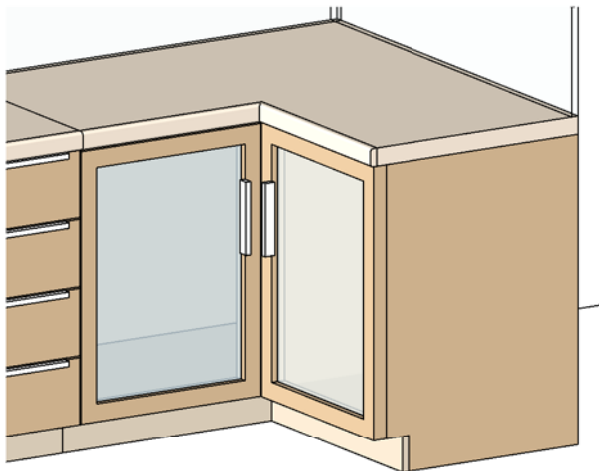

FIG 6

How To Create Corner Unit

In the Type Parameters under:-

Graphics

To Create a Corner Unit, The process is the same as creating the floor units as described on page 1 - 5 under *How To Create Floor Unit Double & Single*. The parameter that needs to be adjusted is *CORNER UNIT VISIBILITY* which controls & switches the visibility on of the Corner Unit & all profiles, as shown in Fig 6

Dimensions

All parameters which are used to control the floor unit cupboard as described on page 1 of 5 under *How To Create Floor Unit* are also used for the Corner Unit
The additional Parameters which can be adjusted to change the are :-

CORNER UNIT WIDTH

(PLEASE REFER TO DIMENSIONS OVERVIEW)

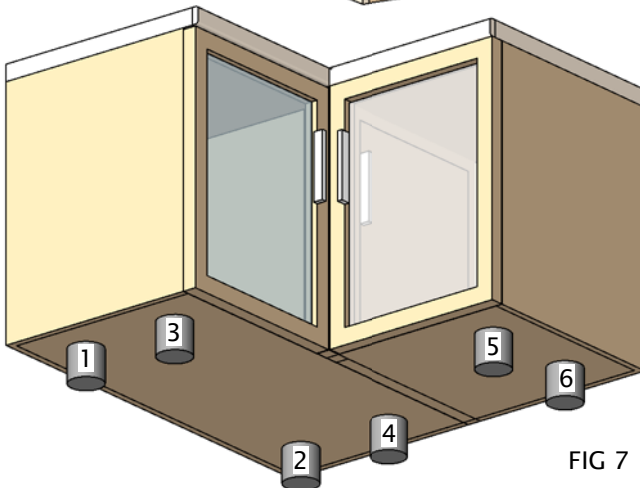

FIG 7

How To Create Back Splash

In the Type Parameters under:-

Graphics

To Create Backsplash on worktop adjust the parameter *BACKSPLASH VISIBILITY* as shown in Image C on Page 9 - 9

Dimensions

The parameters which controls the BACKSPLASH is:-

BACK SPLASH HEIGHT & BACKSPLASH THICKNESS

(PLEASE REFER TO DIMENSIONS OVERVIEW)

How To Create Legs

In the Type Parameters under:-

Graphics

To Create Legs, adjust the parameter *LEGS VISIBILITY* on which controls & switches the visibility on of the Legs as shown in Fig 7

LEGS VISIBILITY is a Integer visibility parameter for each leg, so each number will switch on the visibility as shown in Fig 7
If the *LEGS VISIBILITY* is on integer 7, then all legs will appear
If the *LEGS VISIBILITY* is on integer 0, then all legs will switch off and the result will be Fig 7

NOTE

LEGS VISIBILITY Integers 5 & 6 will only switch on when *CORNER UNIT VISIBILITY* is switched on.
LEGS VISIBILITY Integer 7 will switch on the four legs for a normal unit.

Dimensions

The parameters which controls the Leg Height Is Bottom Base Height
The additional Parameters which can be adjusted to change the legs are :-

*LEG RADIUS, LEG LENGTH, LEG WIDTH
LEG POSITION LEFT & RIGHT & LEG POSITION FRONT & BACK*

(PLEASE REFER TO DIMENSIONS OVERVIEW)

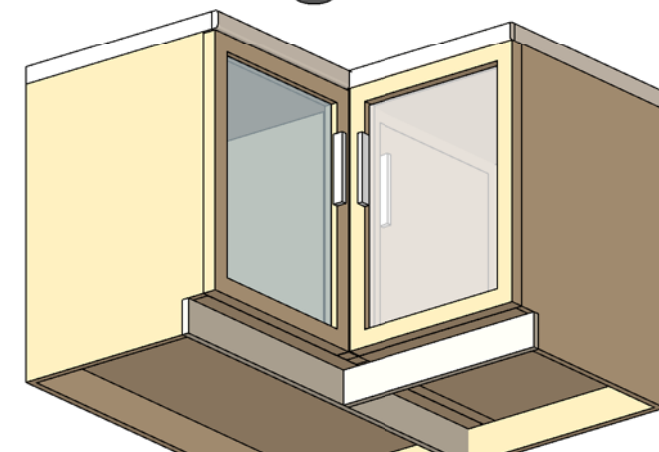

How To Create Shelves & Dividers

The Parameters are:-

A Left Divider, A Left Divider Distance, A Left Divider Height Offset & A Left Divider Height

A Right Divider, A Right Divider Distance, A Right Divider Height Offset & A Right Divider Height

A Left Shelves, A Left Shelves Offset, A Left Shelves Distance & A Left Shelves Count

A Right Shelves, A Right Shelves Offset, A Right Shelves Distance & A Right ShelvesCount

Shelves and Dividers parameters are found in the Dimensions and can be adjusted almost in everyway

There are 2 Dividers, 1 on the Left & 1 on the Right
These Dividers have a Distance from the Left & Right and also have a Height and Height Offset

The Shelves have a offset from the bottom and a shelve distance to the next shelve. These shelve can have an array of Shelves

NOTE

All Dividers & Shelves have a Visibility when all dimension are 0 then Dividers & Shelves will switch off visibility

(PLEASE REFER TO DIMENSIONS OVERVIEW)

How To Create Symbol Lines

In the Type Parameters under:-

Graphics

To Create Symbol Lines adjust the parameter *SHOW SYMBOL LINES* the result will be Fig 8

To Have localised symbol lines, having the symbol lines showing the opposite side showing in Elevation adjust the parameter *SHOW SYMBOL LINES FROM HINGE SIDE* the result will be a change from Fig 8

How To Create Fix Panel

In the Type Parameters under:-

Graphics

To Create Symbol Lines adjust the parameter *FIX PANEL* the result will be Fig 8

To adjust the offset of the fix panel, the parameter is called *FIX PANEL* the result will be shown as Fig 8. This adjustment only works when it is a single door unit. This setup is ideal if you have a small kitchen setup, and on the return wall there is a different setup configuration of a corner unit. The Dimension Parameter that is adjusted is *FIX PANEL OFFSET*

How To Create an Extractor Fan

In the Type Parameters under:-

Graphics

To Create an extractor fan adjust the parameter *EXTRACTOR FAN* the result will be Fig 9

Dimensions

The Additional parameters that need to be adjusted are
EXTRACTOR HOOD BOTTOM WIDTH, EXTRACTOR HOOD BOTTOM DEPTH, EXTRACTOR HOOD BOTTOM HEIGHT, EXTRACTOR HOOD MIDDLE BOTTOM SIDE OFFSET, EXTRACTOR HOOD MIDDLE TOP FRONT OFFSET, EXTRACTOR HOOD MIDDLE TOP BACK OFFSET, EXTRACTOR HOOD MIDDLE TOP RIGHT OFFSET, EXTRACTOR HOOD MIDDLE LEFT FRONT OFFSET, EXTRACTOR HOOD TOP HEIGHT, EXTRACTOR HOOD TOP WIDTH, EXTRACTOR HOOD TOP DEPTH & EXTRACTOR HOOD RADIUS

The Results of changing the values of these parameters are shown on Page 14 of 14 from Fig 30 to 35

(PLEASE REFER TO DIMENSIONS OVERVIEW)

How To Create Drawers on Top or Bottom

In the Type Parameters under:-

Graphics

To Create swap of Drawers & Doors adjust the parameter *DRAWERS ON BOTTOM* the result will be Fig 10

If Selected the Drawers will be place on the bottom of the Doors
If Unselected the Drawers will be placed on top of the Doors

It is very easy to setup a combination of Door and Drawers with changing just a few Parameters. You can change between a single and double doors with selecting *DOUBLE SWING* and choose the number of Drawers by adjusting just one Parameter *DRAW COUNT*. To swap the position of the Door and the Drawers, just by selecting Drawers On Bottom.

The the Height of the Kitchen Unit is automatically adjusted by the number of drawers with the parameter *DRAW COUNT* and the *DRAW HEIGHT*.

If you do not want the Draw count & Draw Height to determine the Height of the unit simple select the parameter under Graphic, *UNIT HEIGHT LOCK*
This lets you lock the Height of the Kitchen Unit which results in the automatic adjustments of the Drawers Heights within the set height as shown in Fig 10

(PLEASE REFER TO DIMENSIONS OVERVIEW)

FIG 8

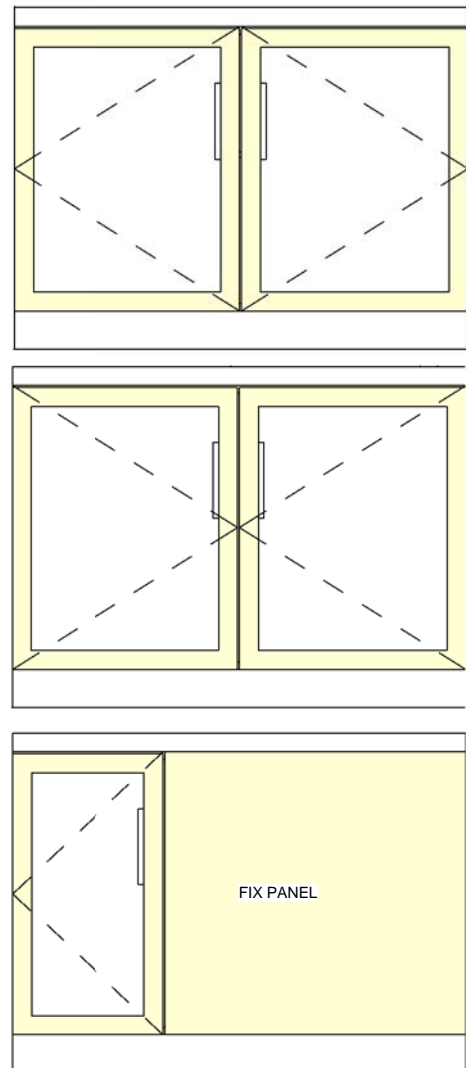

FIG 9

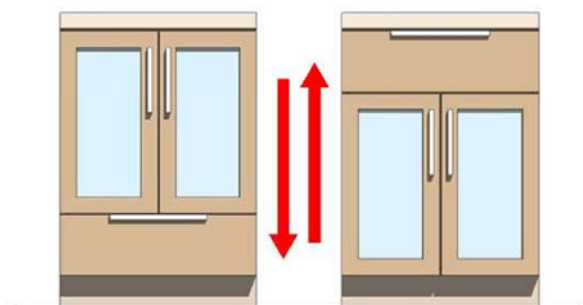
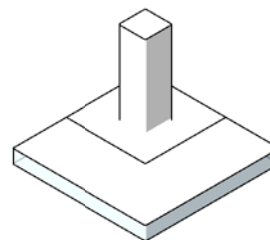
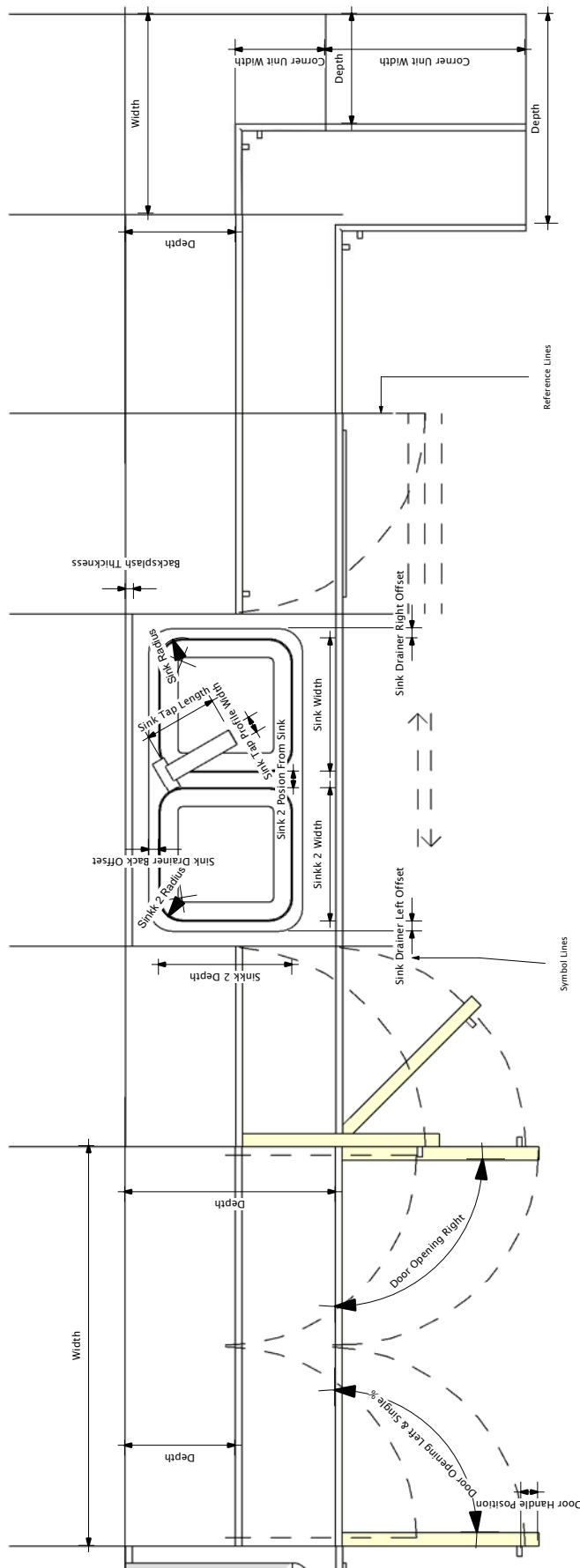

FIG 10

DIMENSIONS OVERVIEW



PLAN
1/20

DIMENSIONS OVERVIEW

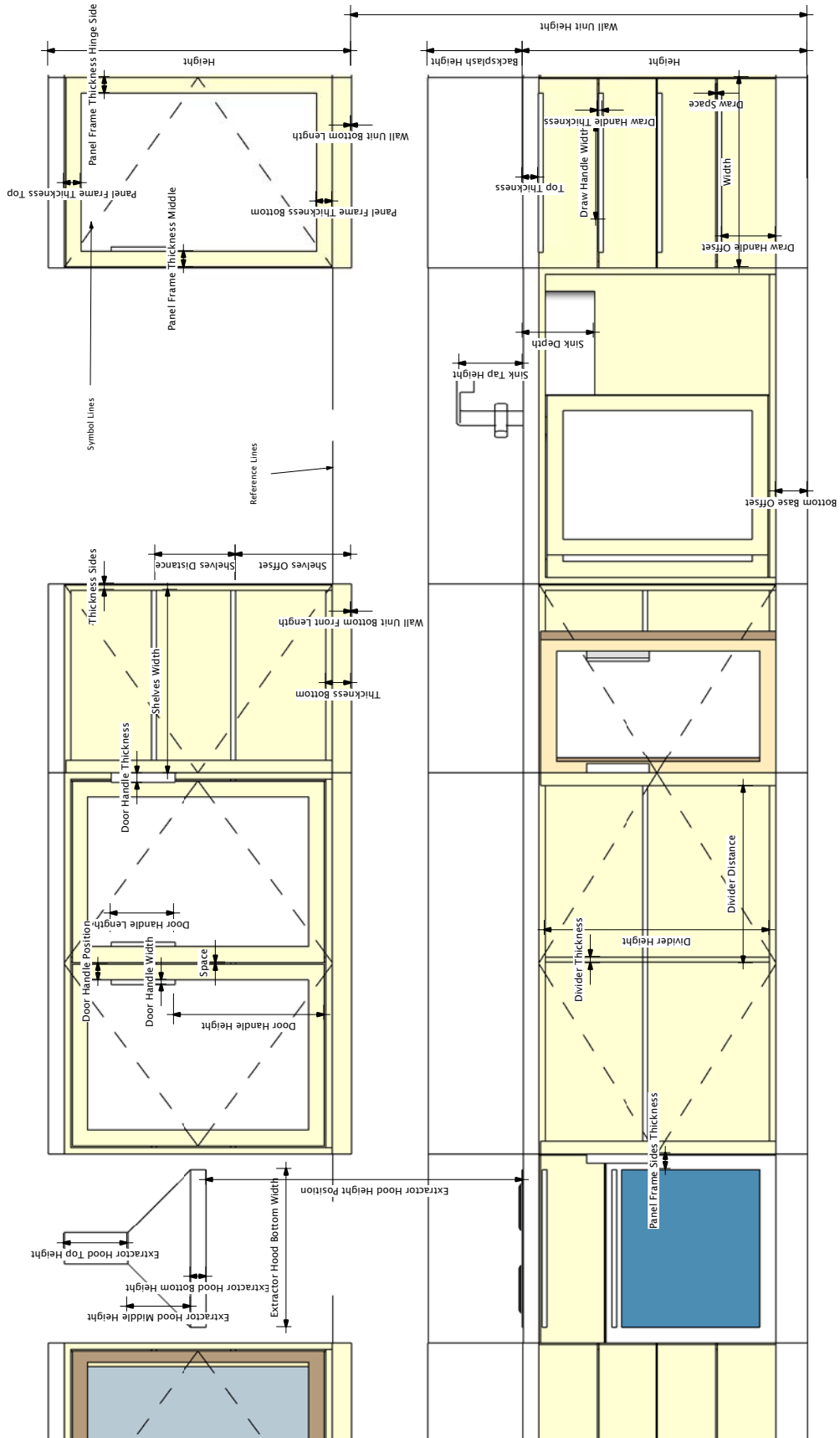

ELEVATION
1/20

DIMENSIONS OVERVIEW

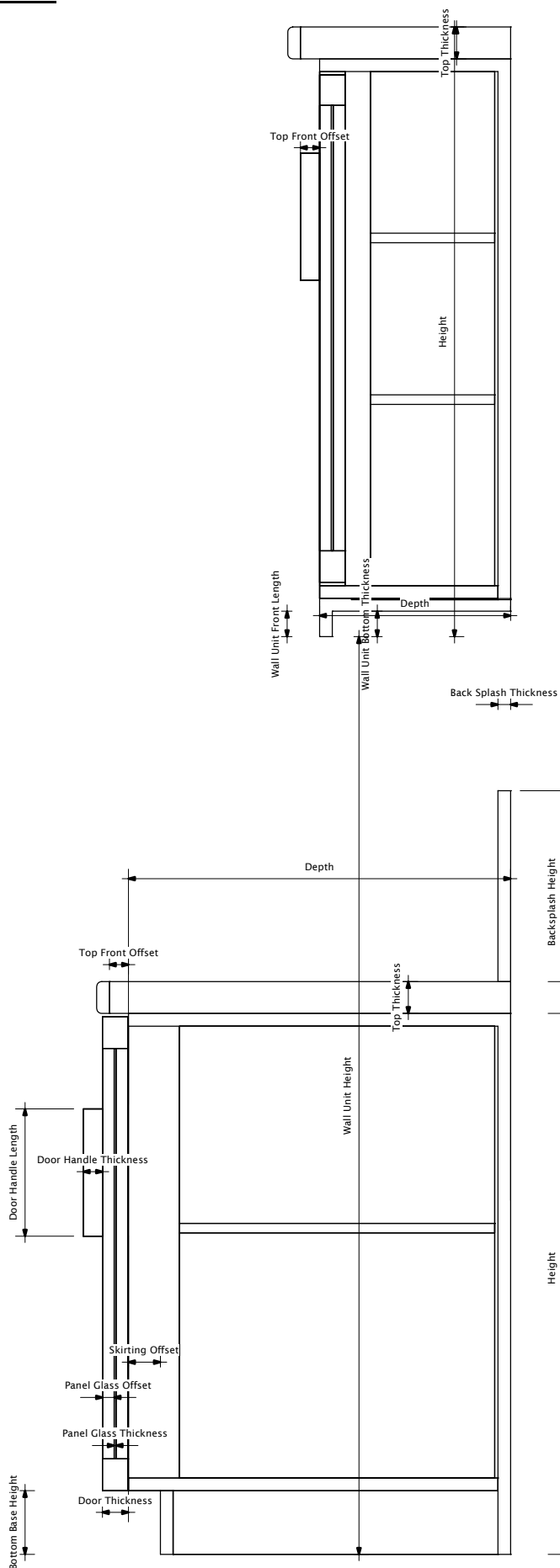

FAMILY TYPES OVERVIEW

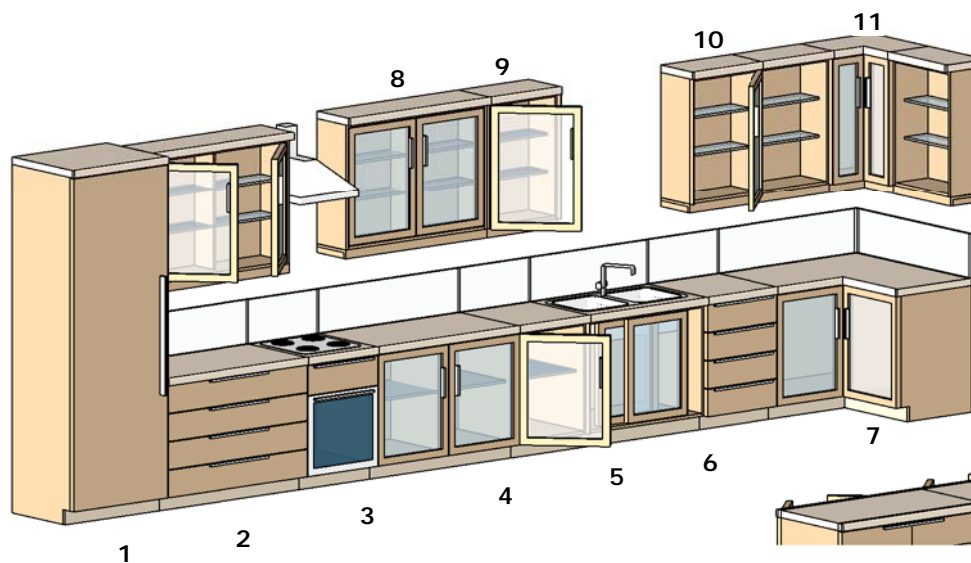

- | | |
|----|-------------------|
| 1 | FRIDGE |
| 2 | DRAWERS UNIT |
| 3 | COOKER/ OVEN |
| 4 | DOUBLE FLOOR UNIT |
| 5 | SINGLE FLOOR UNIT |
| 6 | SINK |
| 7 | CORNER UNIT |
| 8 | DOUBLE WALL UNIT |
| 9 | SINGLE WALL UNIT |
| 10 | SHELL WALL UNIT |
| 11 | WALL CORNER UNIT |

GRAPHICS

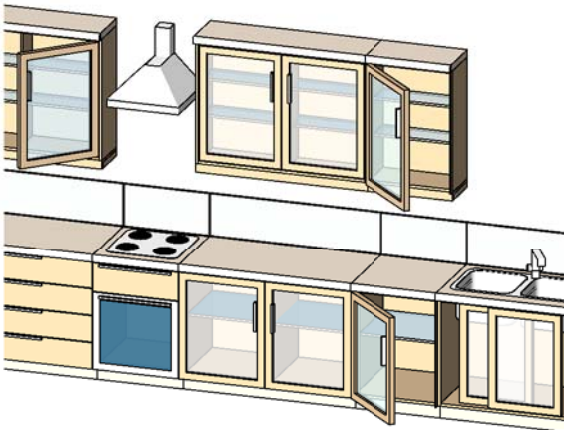

IMAGE A

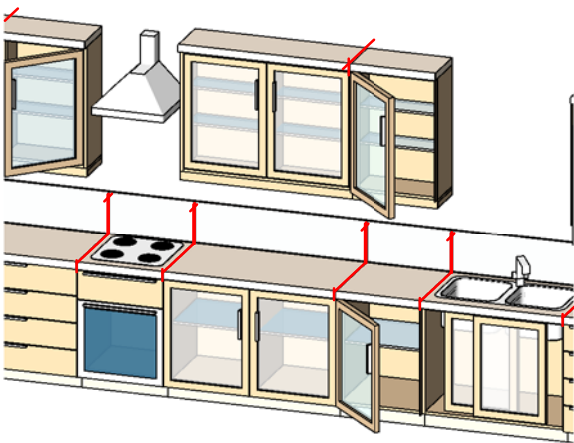

IMAGE B



IMAGE C

How to remove lines from once family is setup in the project

Once you have set up your family in the project, you will notice that on the worktop there are lines that you may not want to show as shown above in Image A.

To remove these lines, there is a Tool in the Tool Bar which is called "Line Works"

In the Type Selector, select the line style "Invisible Lines" to apply to the edges in the model.

With the Linework tool active & "Invisible Lines" Category selected, in the drawing area, highlight the edge lines by clicking once as shown in red lines in Image B.

Then click again and the result will be that the Line will disappear as shown in Image C

We deliver this family as a furniture Category which does not allow you to join the units and clear the lines between. If it is not important to you that the family is categorized as furniture and you do not want to have the dividing lines visible, then you can open the family in the family editor and change the family category from Furniture to Generic, this will then allow you to join the units together once loaded back in to your project.

SAMPLE SETUP OPTIONS

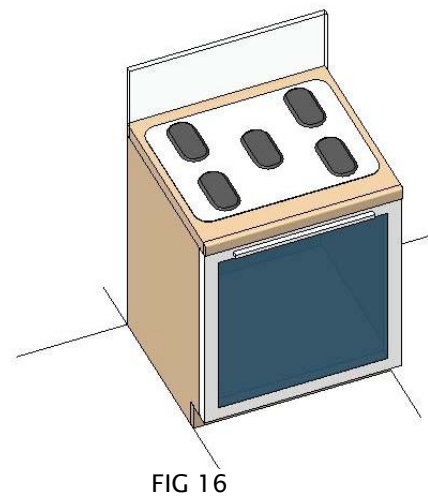
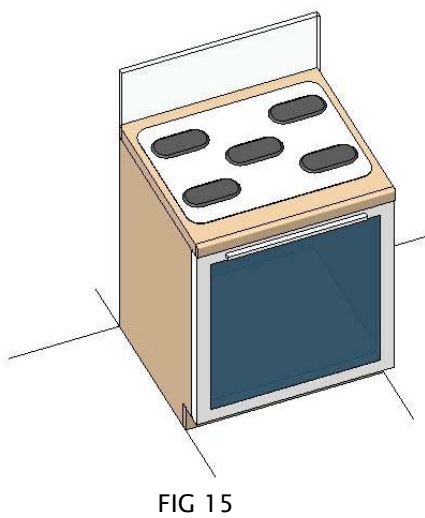
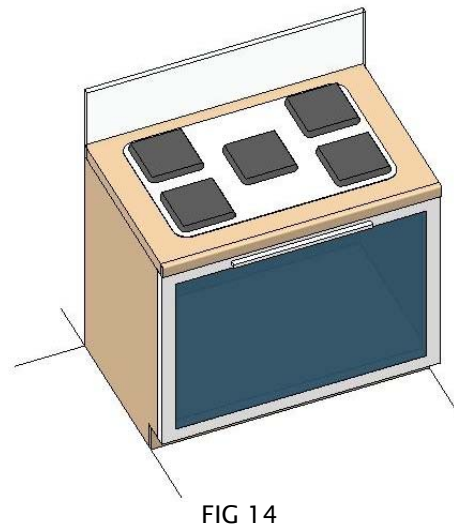
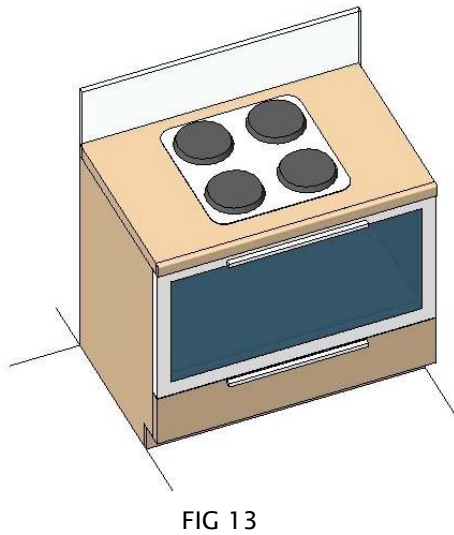
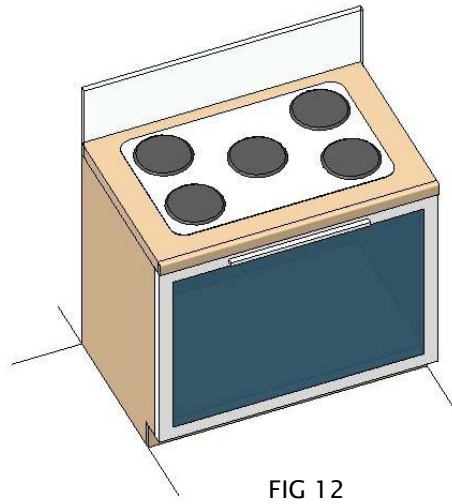
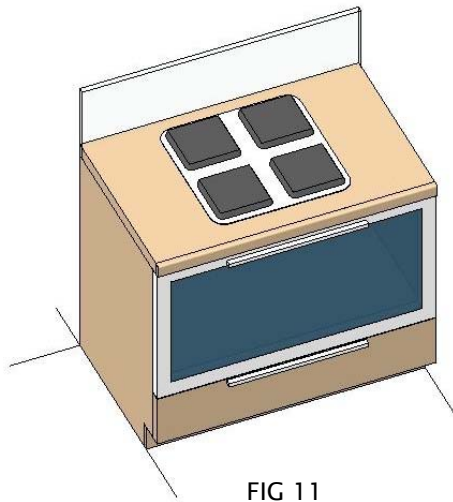

SAMPLE SETUP OPTIONS

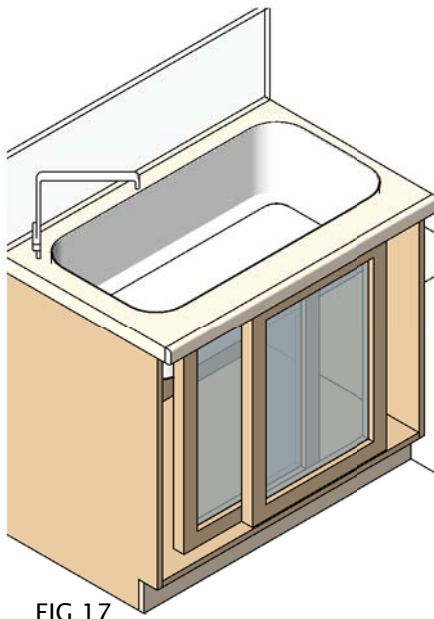

FIG 17

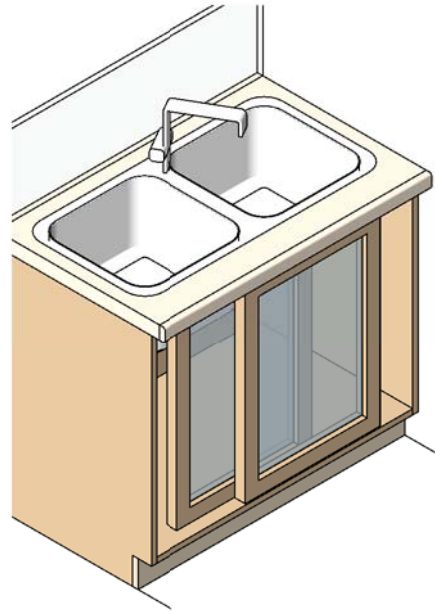

FIG 18

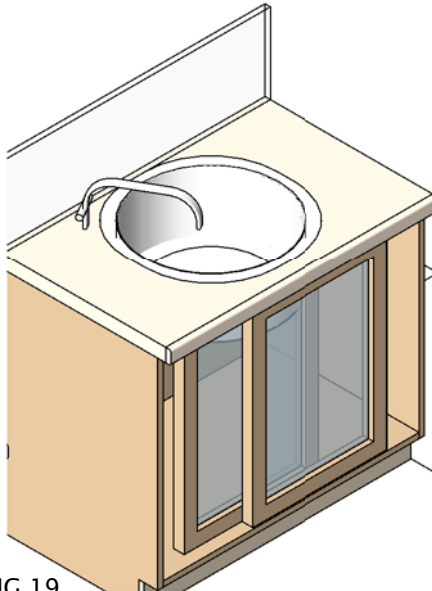

FIG 19

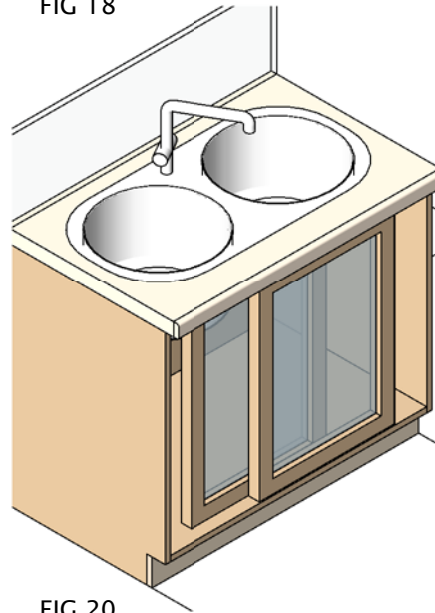

FIG 20

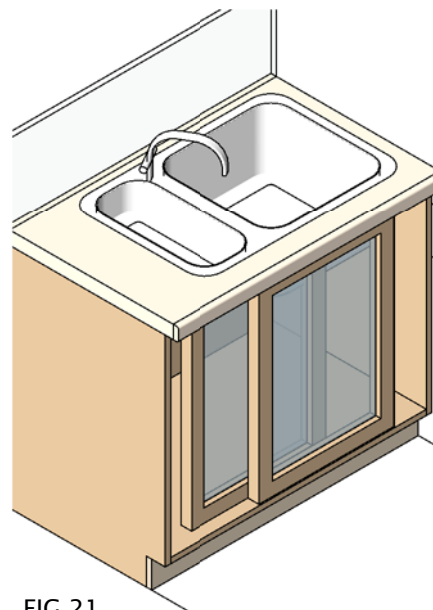

FIG 21

SAMPLE SETUP OPTIONS

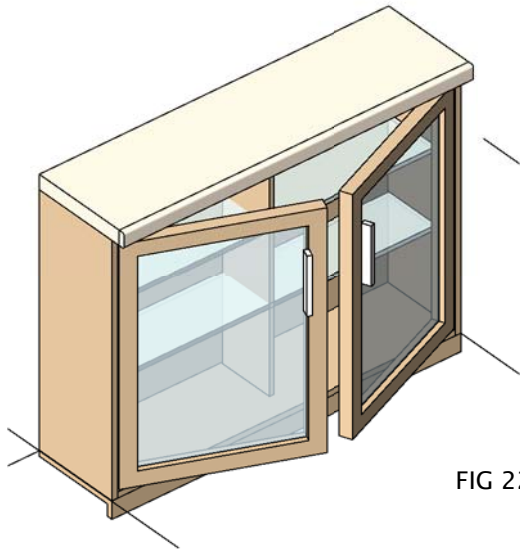

FIG 22

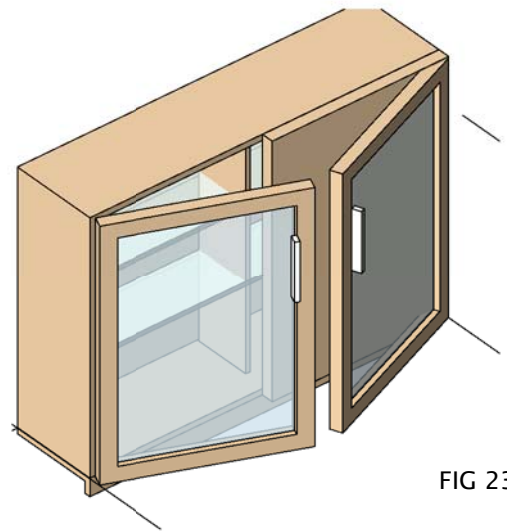

FIG 23

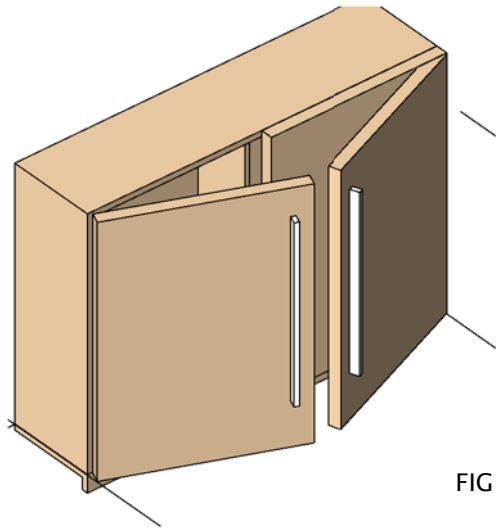

FIG 24

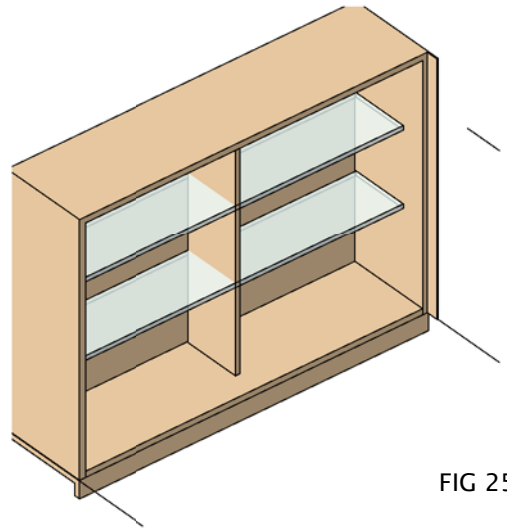

FIG 25

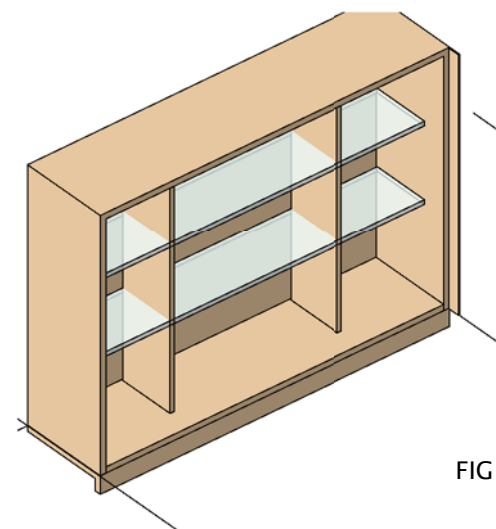

FIG 26

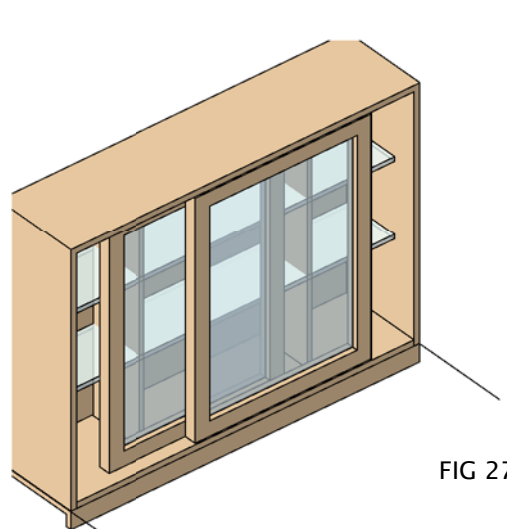

FIG 27

SAMPLE SETUP OPTIONS

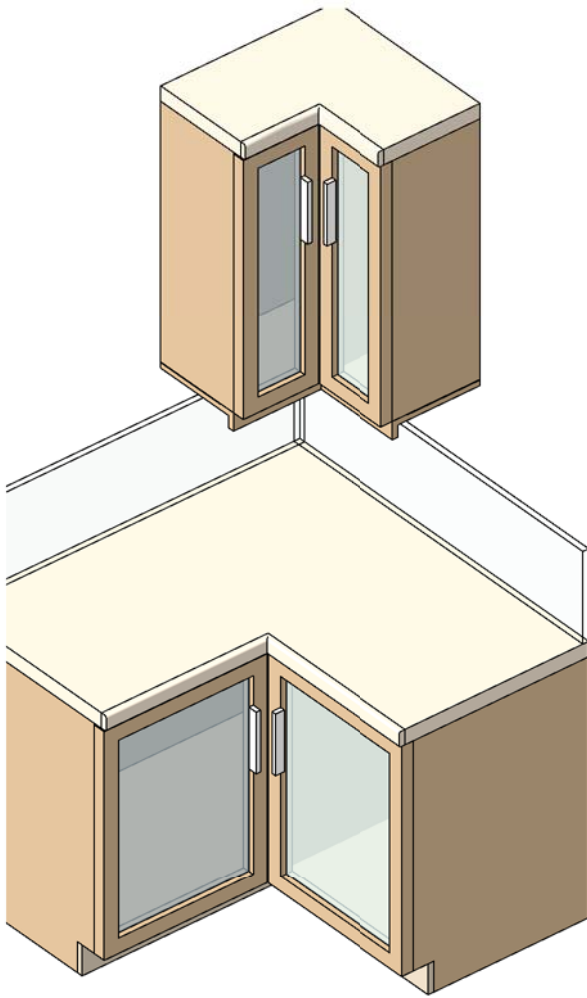

FIG 28

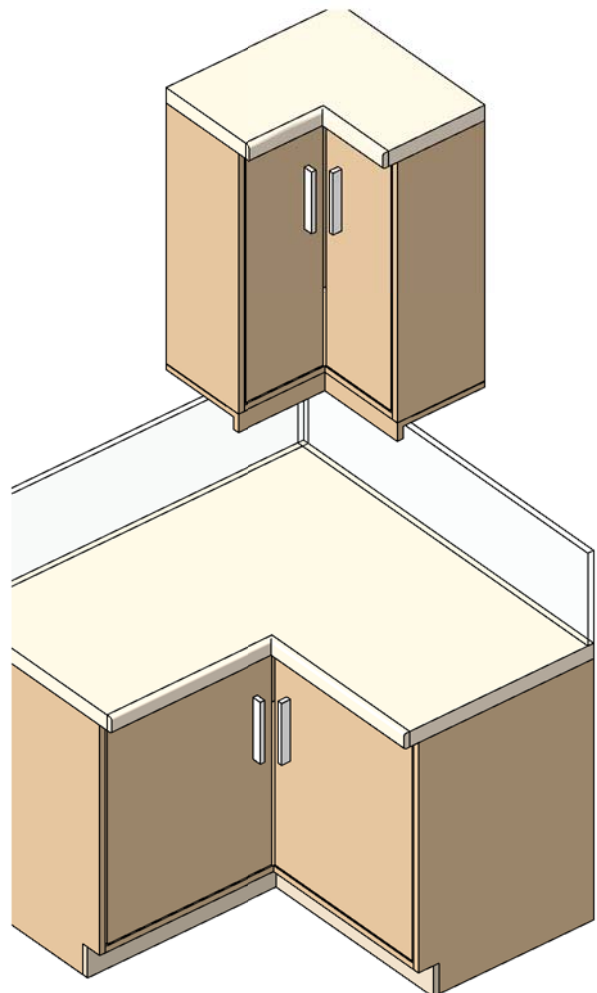

FIG 29

SAMPLE SETUP OPTIONS

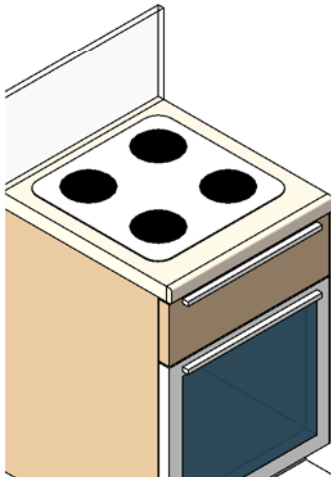
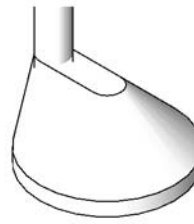
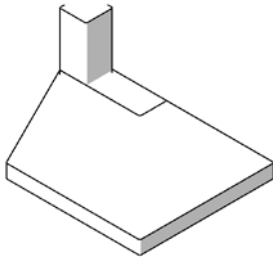

FIG 30

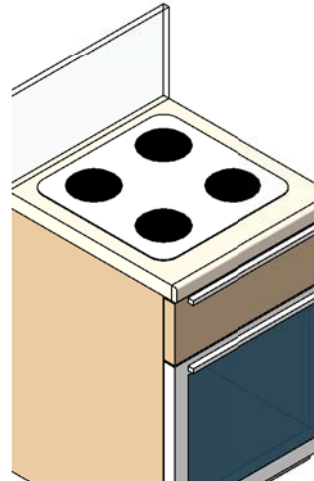

FIG 31

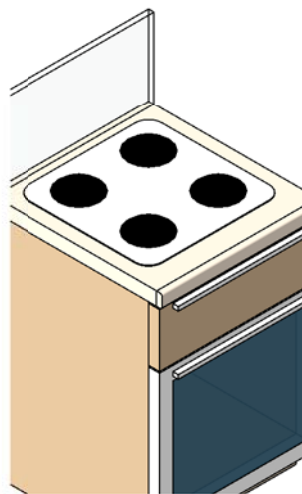
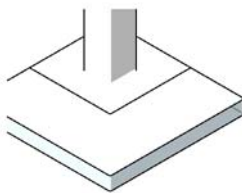
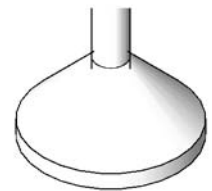
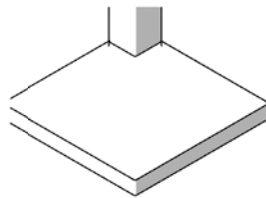

FIG 32

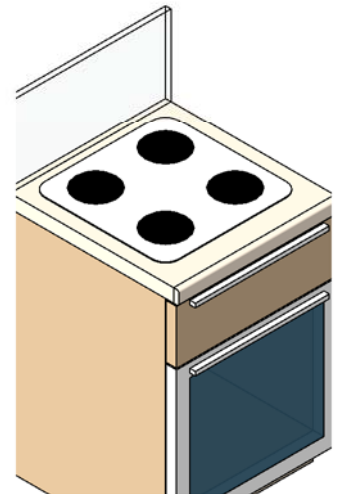
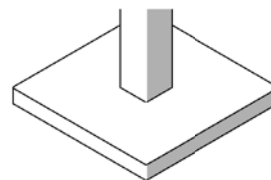

FIG 33

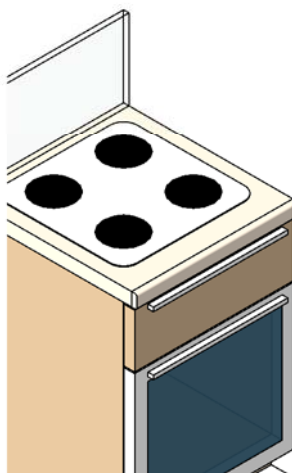

FIG 34

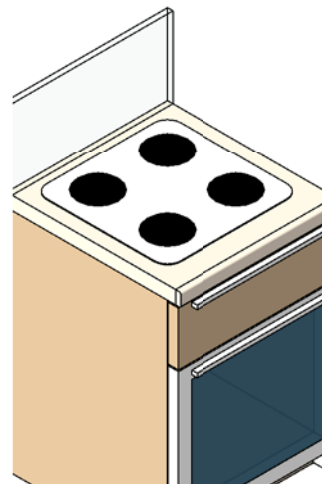

FIG 35

NEW FEATURES IN VERSION 3.2

