

DOOR MANUAL

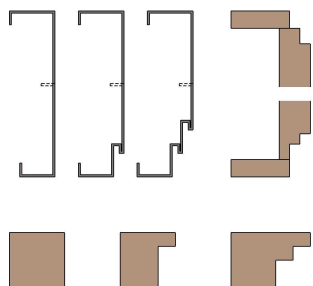

DOOR FEATURES OVERVIEW



FRAME
REBATES

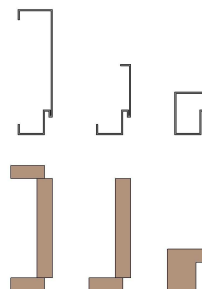

FRAME
TYPES

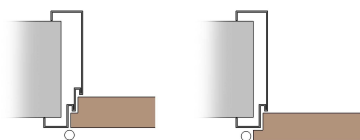

DOOR FLUSH

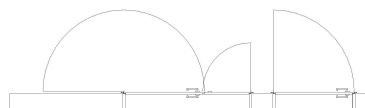

SYMBOL LINES

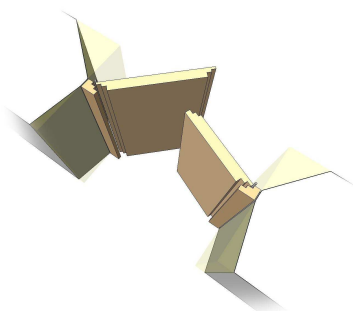

WOOD FRAME

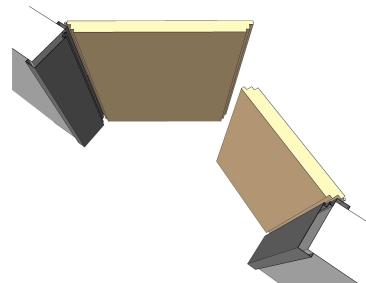

METAL FRAME

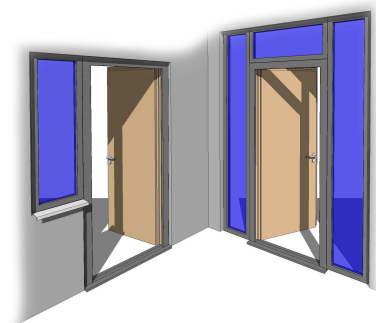

SIDE LIGHTS &
TRANSOM

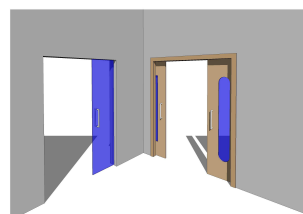

PANEL GLAZING

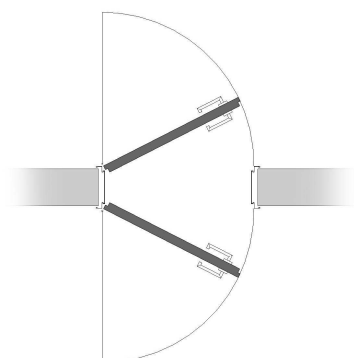

DOUBLE PANEL

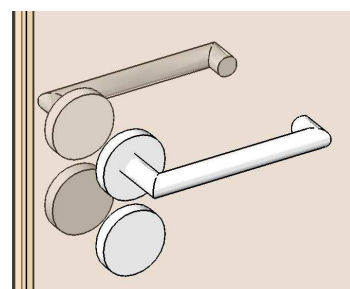

DOOR ACCESSORIES

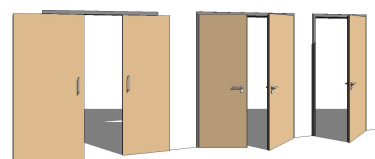

DOOR TYPES

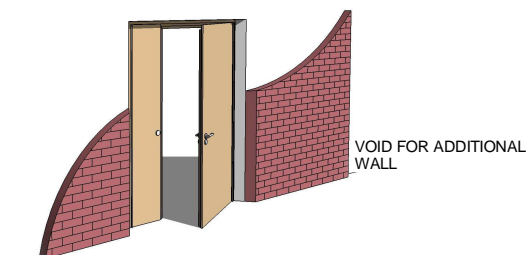

VOID FOR ADDITIONAL
WALL

DIMENSIONS OVERVIEW

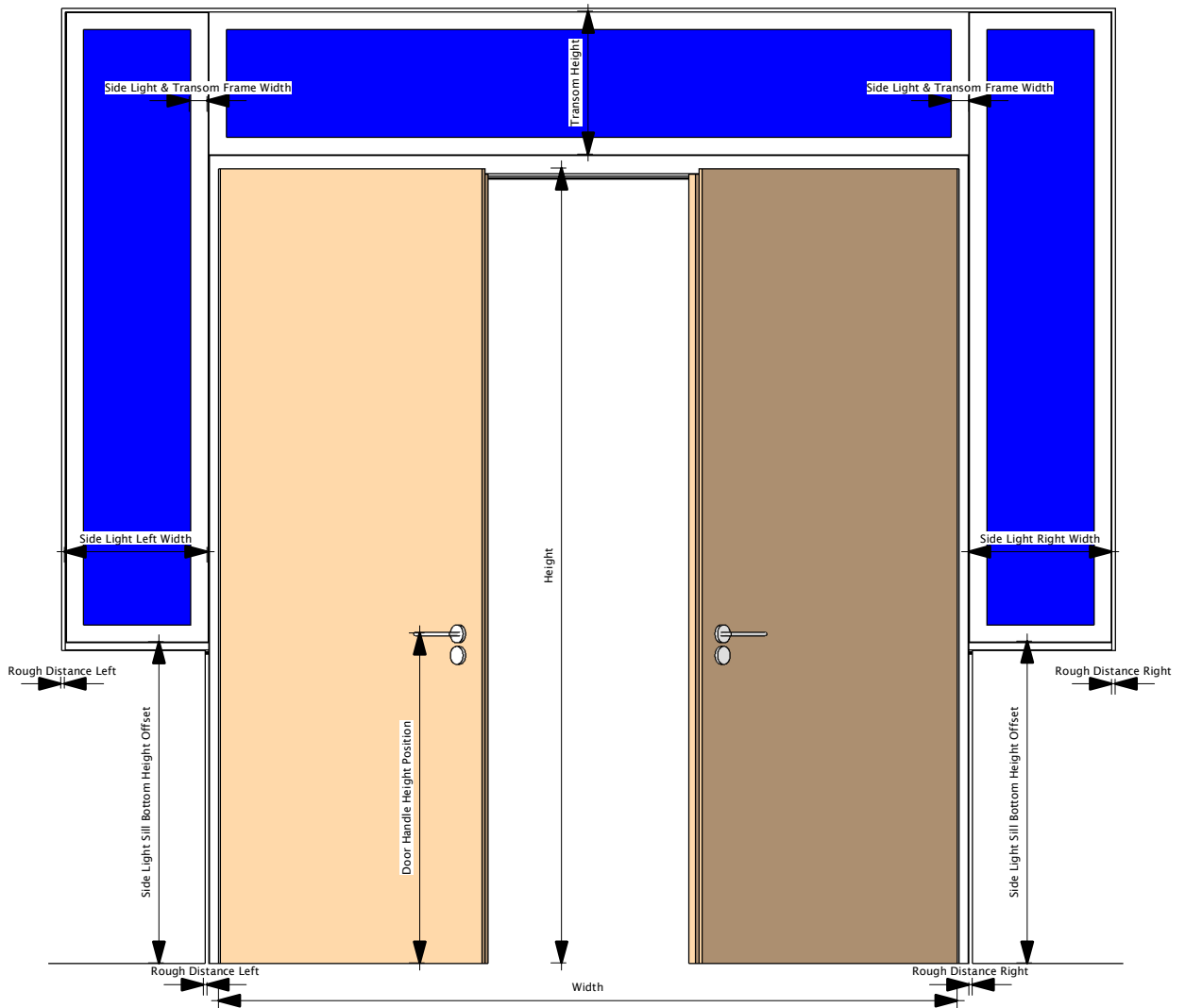
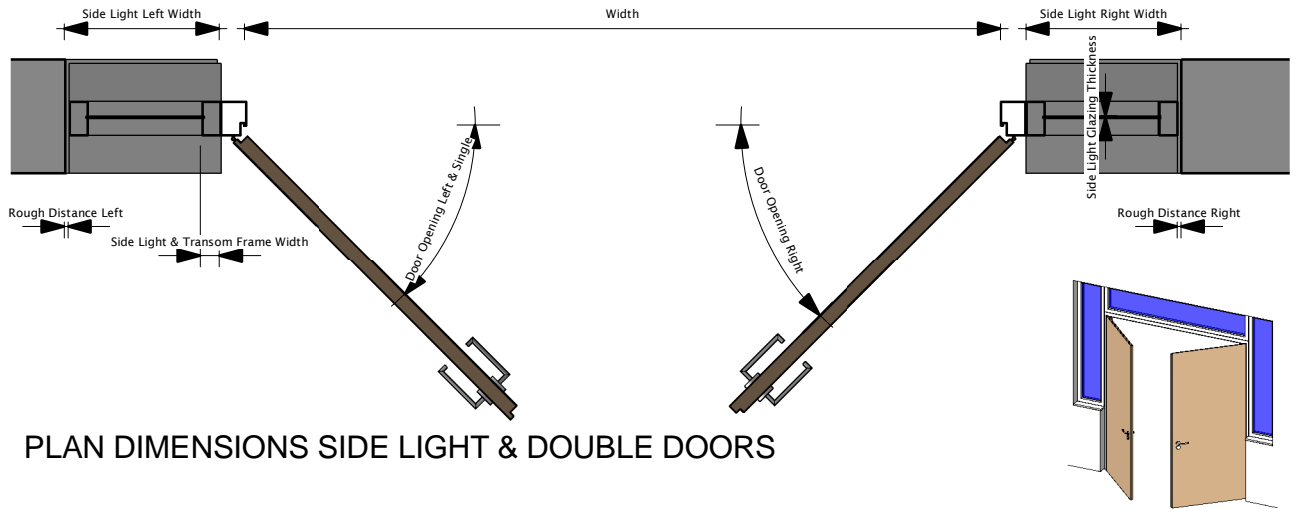

DIMENSIONS OVERVIEW

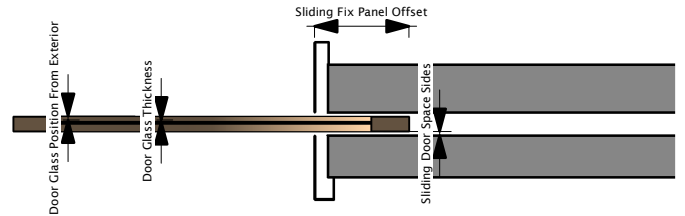
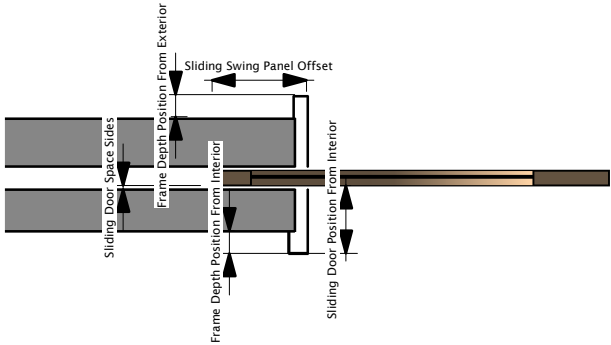

PLAN DIMENSIONS SLIDING DOORS

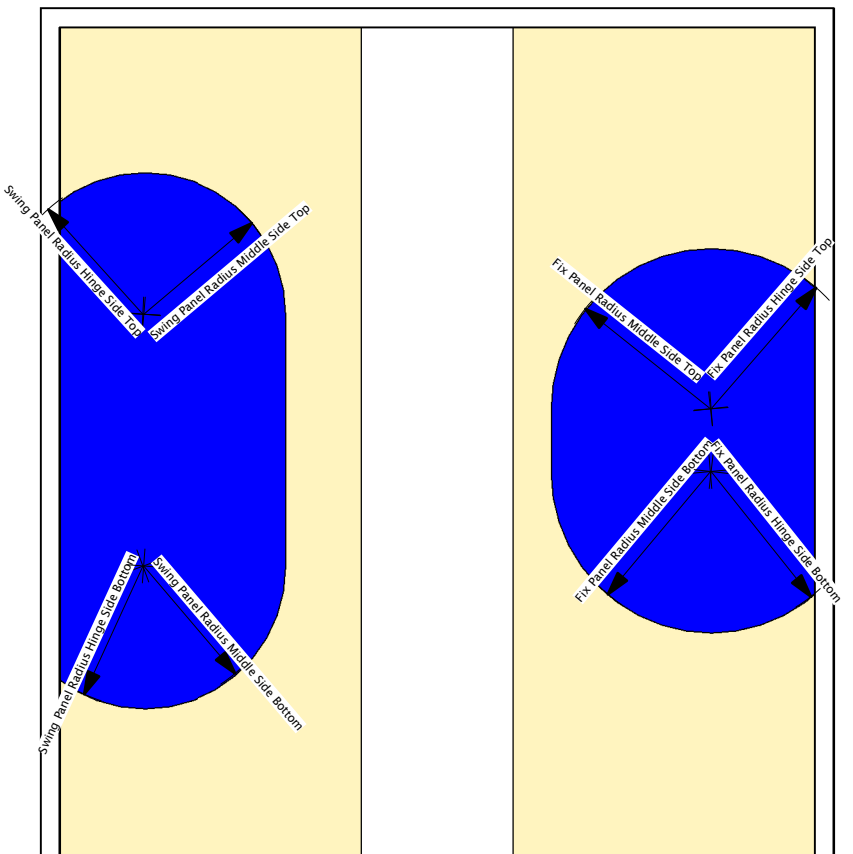
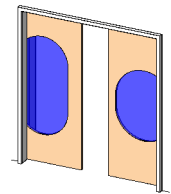

ELEVATION PANEL DIMENSIONS SLIDING DOORS & OPENING

DIMENSIONS OVERVIEW



PLAN DIMENSIONS TAPERED REVEALS

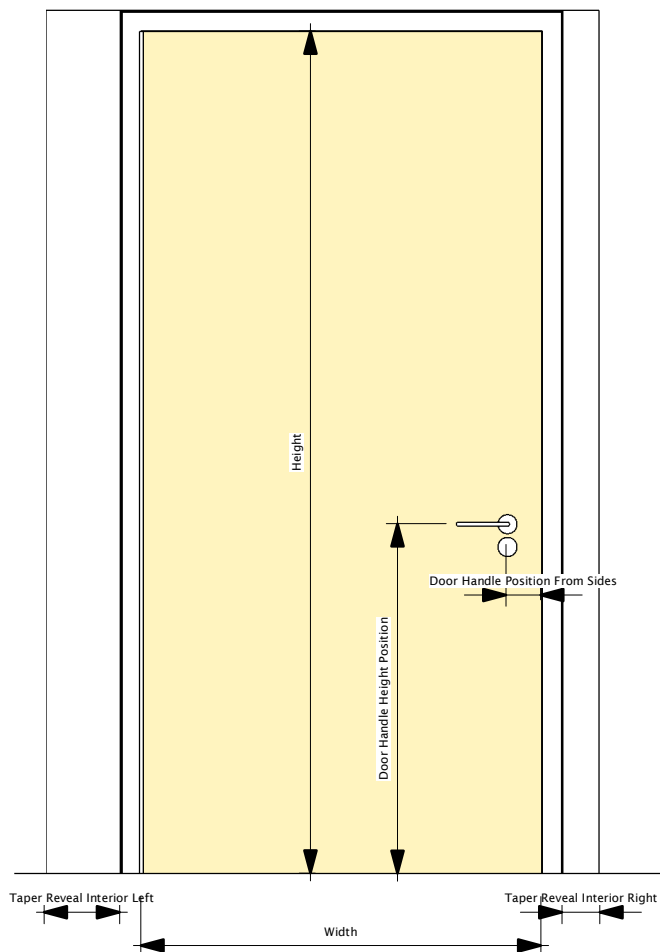
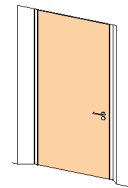

ELEVATION DIMENSIONS TAPERED REVEALS

DIMENSIONS OVERVIEW

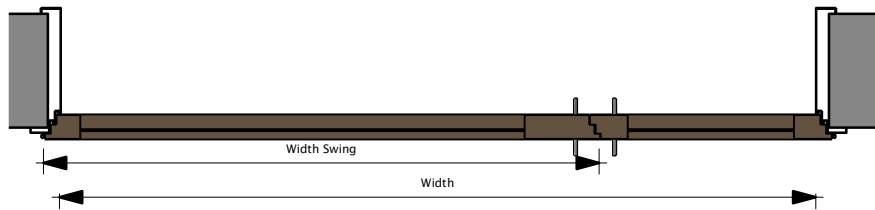

PLAN DIMENSIONS DOUBLE DOORS

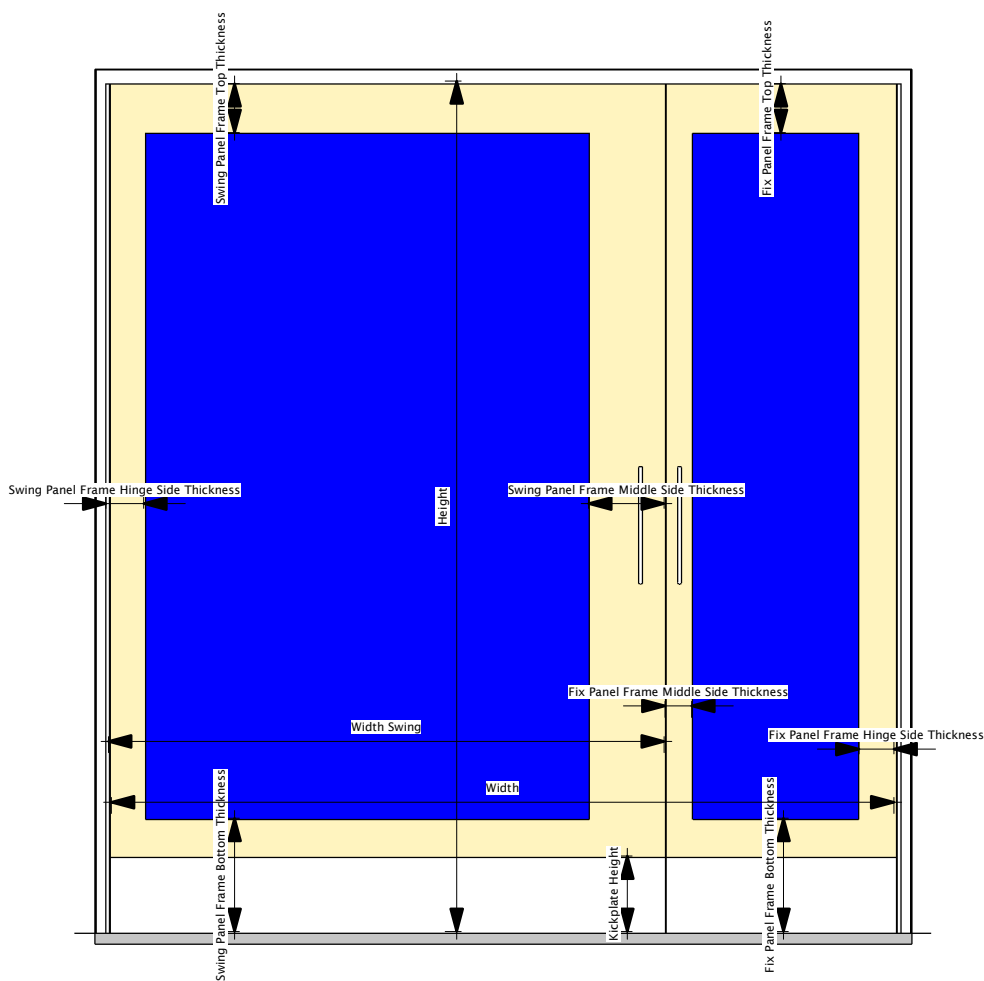
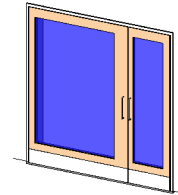

ELEVATION DIMENSIONS DOUBLE DOORS & GLAZING OPENING

DIMENSIONS OVERVIEW

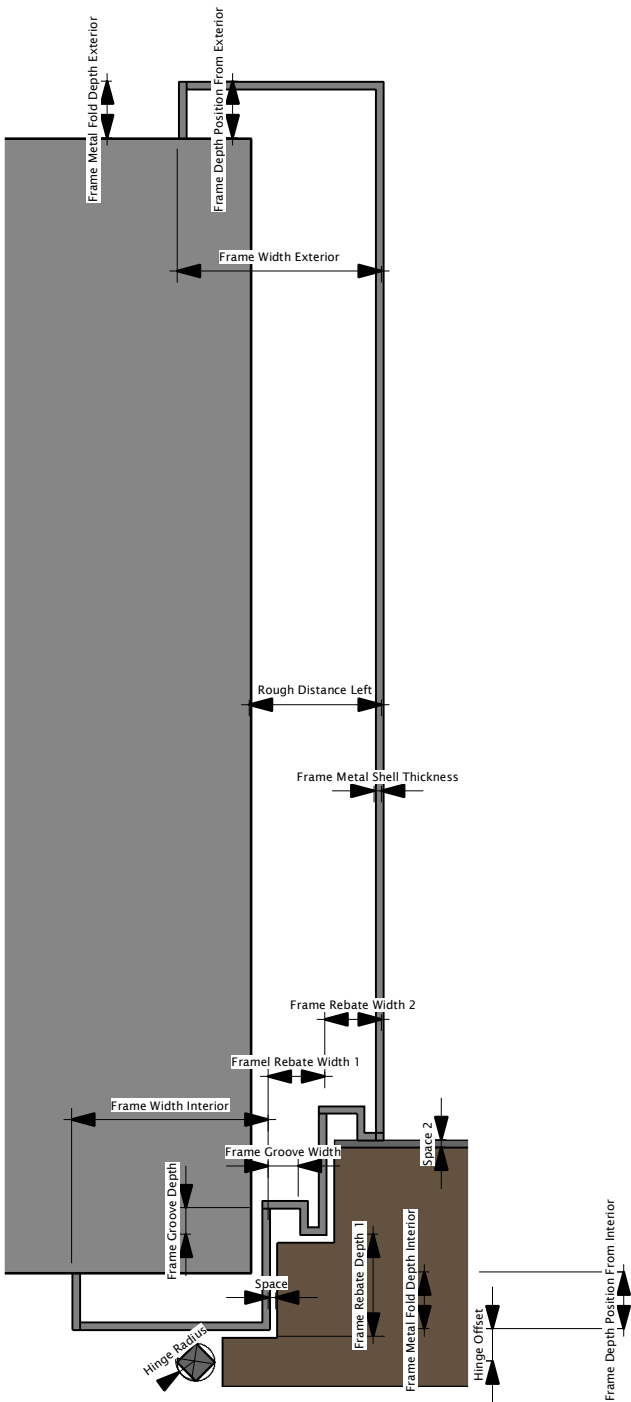

PLAN DETAIL OF METAL FRAME TYPE 1

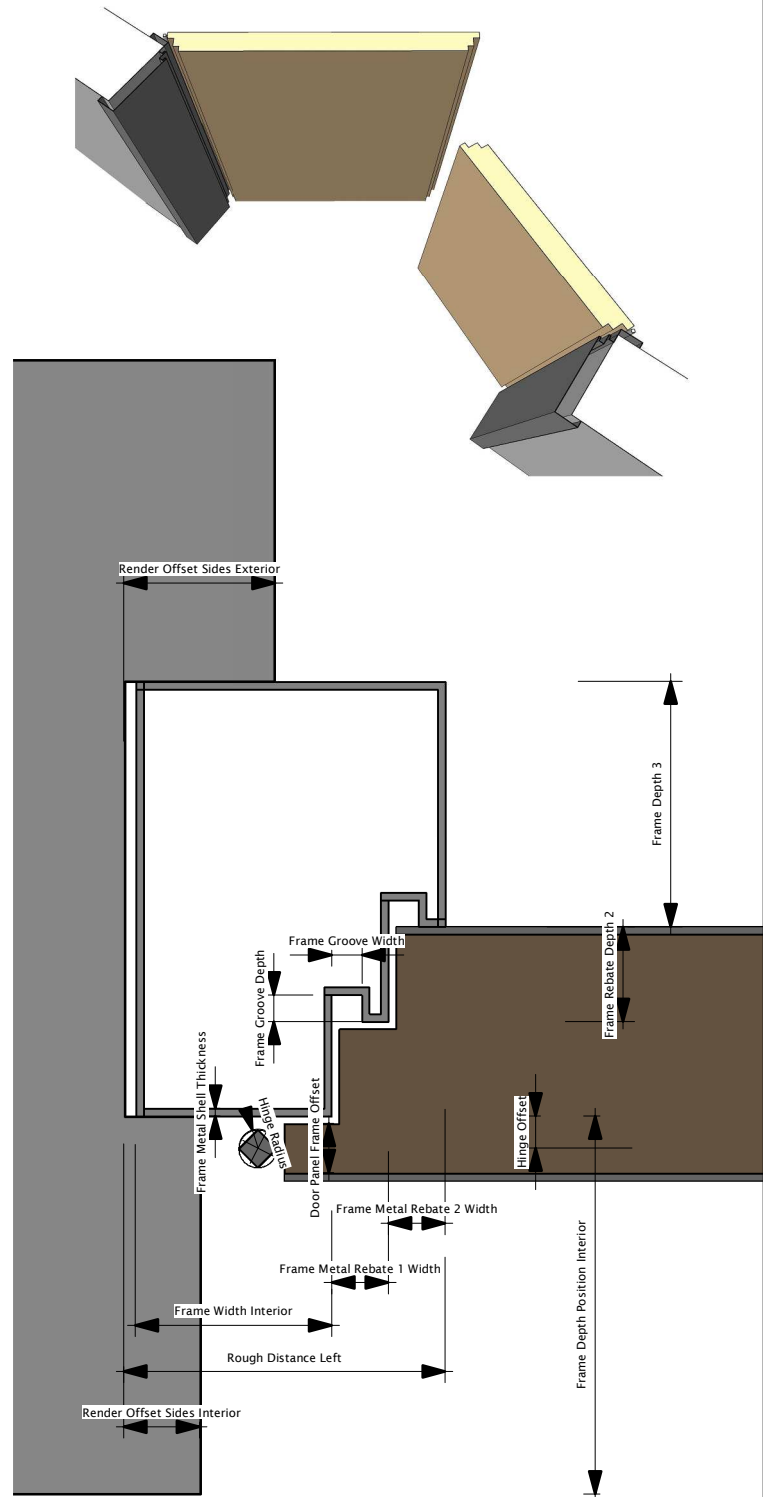

PLAN DETAIL OF METAL FRAME TYPE 3

DIMENSIONS OVERVIEW

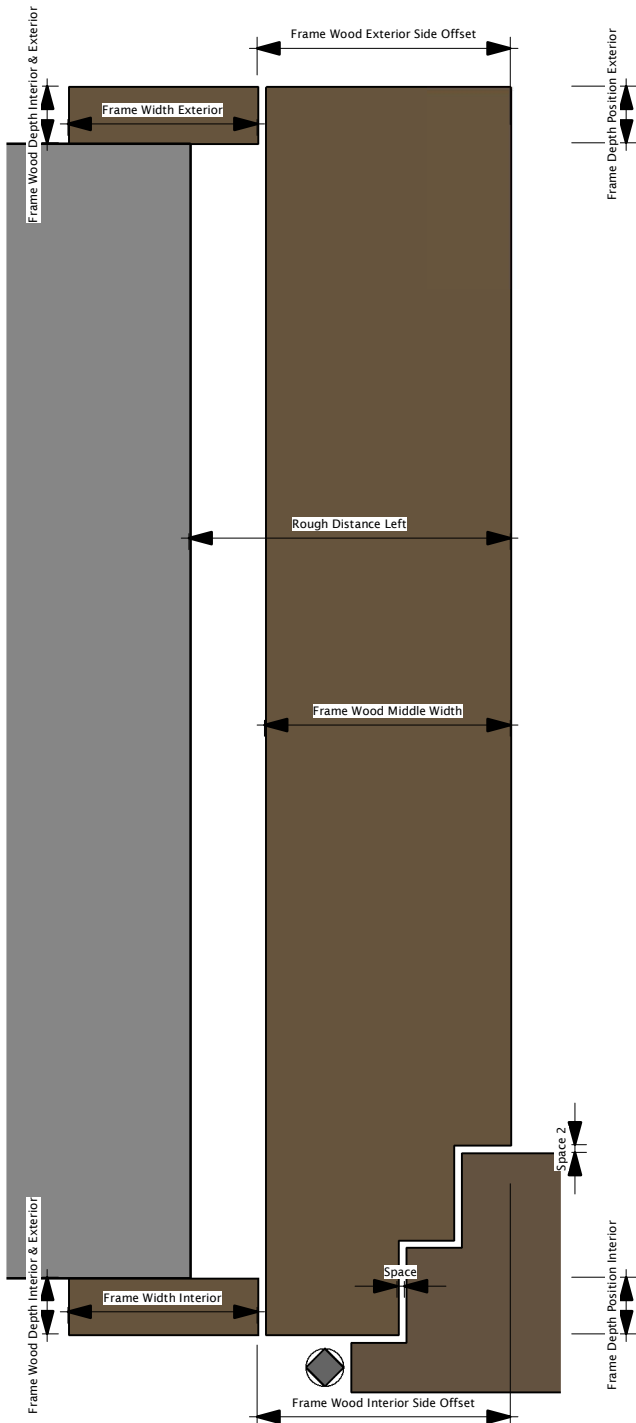

PLAN DETAIL Of WOOD FRAME TYPE 1

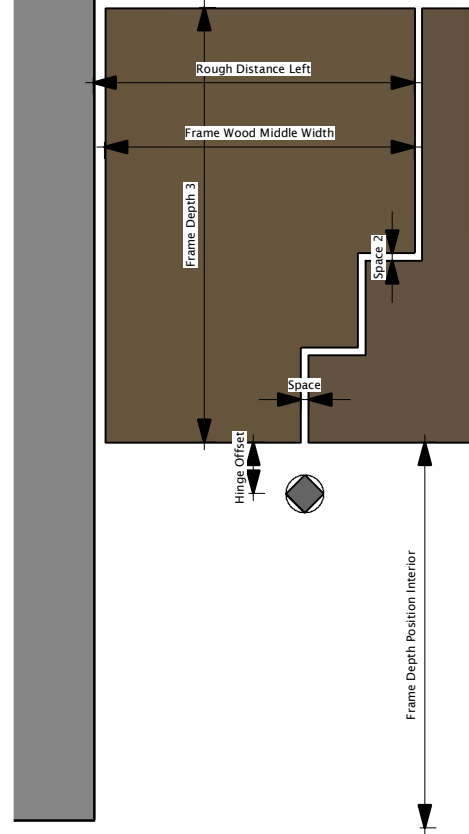
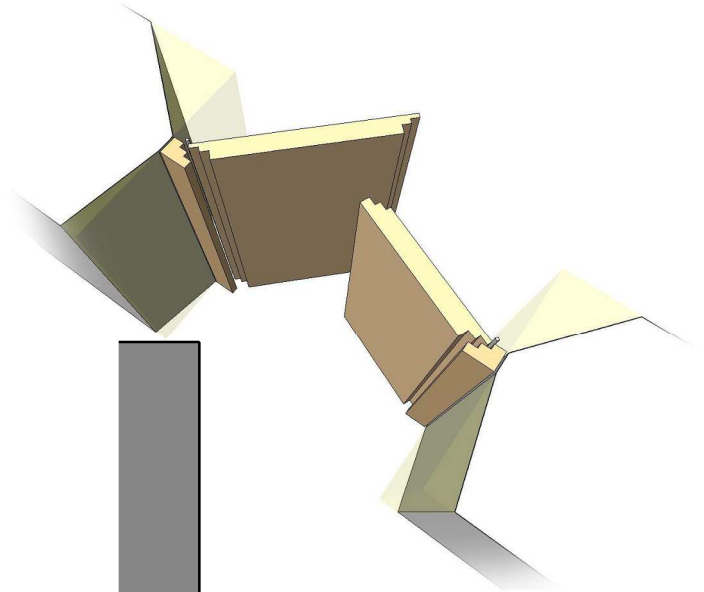

PLAN DETAIL Of WOOD FRAME TYPE 3

DIMENSIONS OVERVIEW

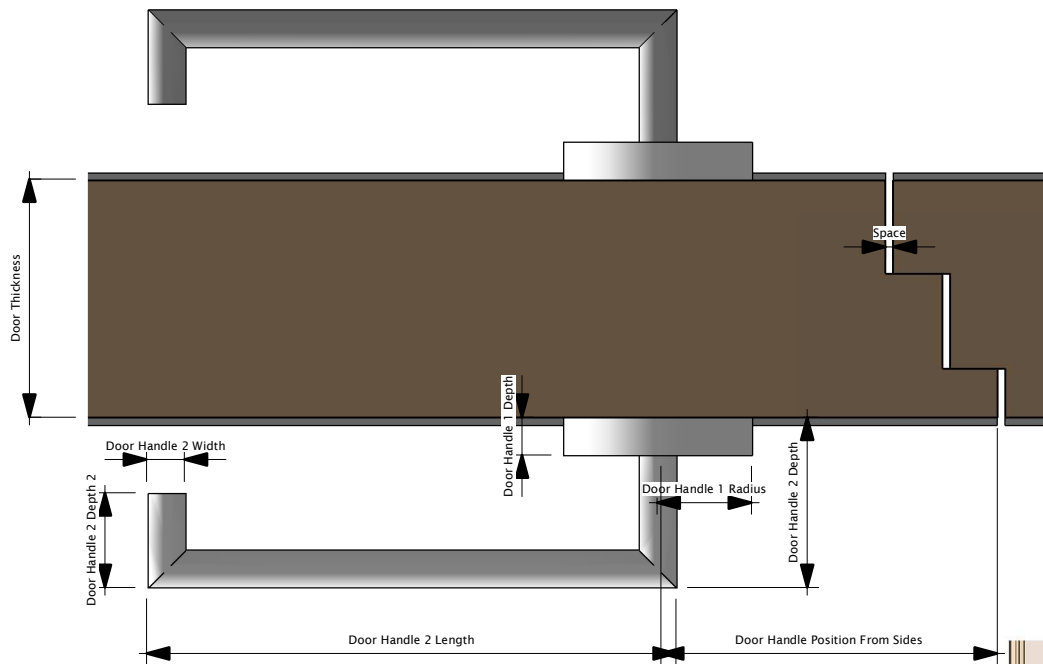

PLAN DETAIL OF HANDLE

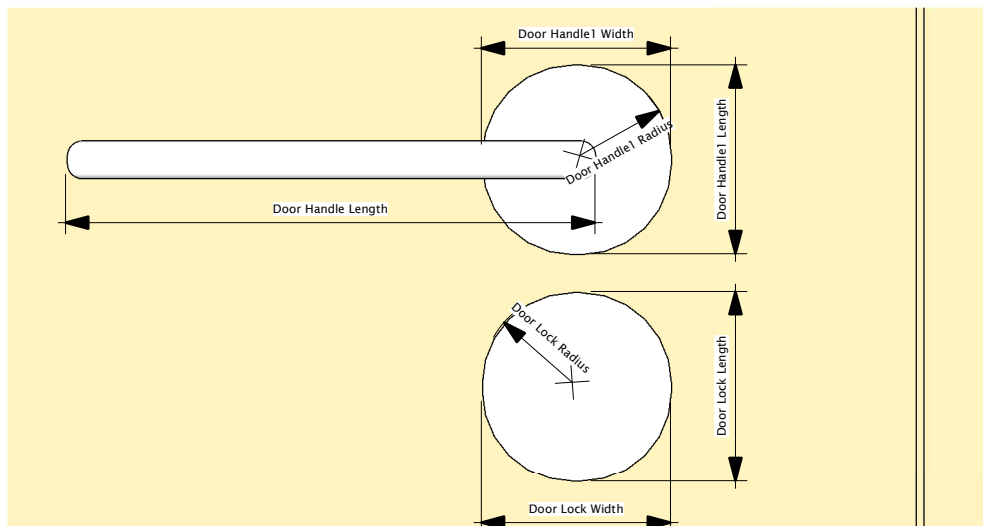
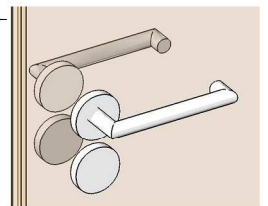

ELEVATION DOOR ACCESSORIES

SECTION OVERVIEW

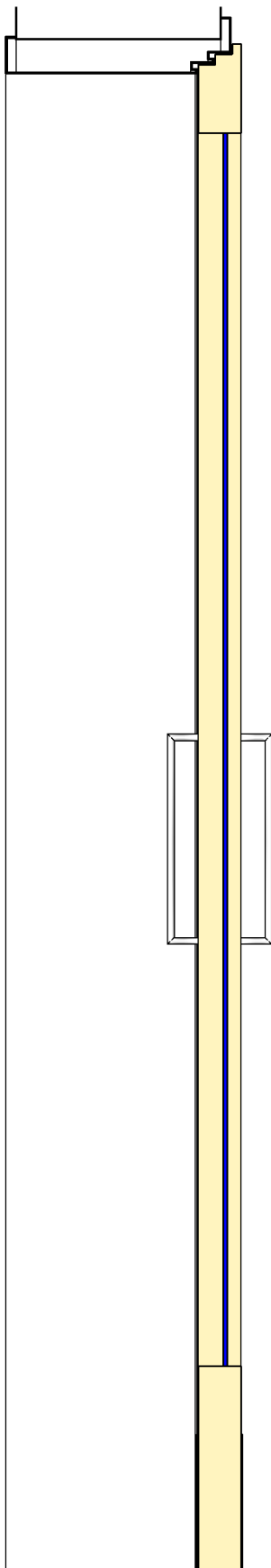

Frame Type 1
Section 1 Closure Frame

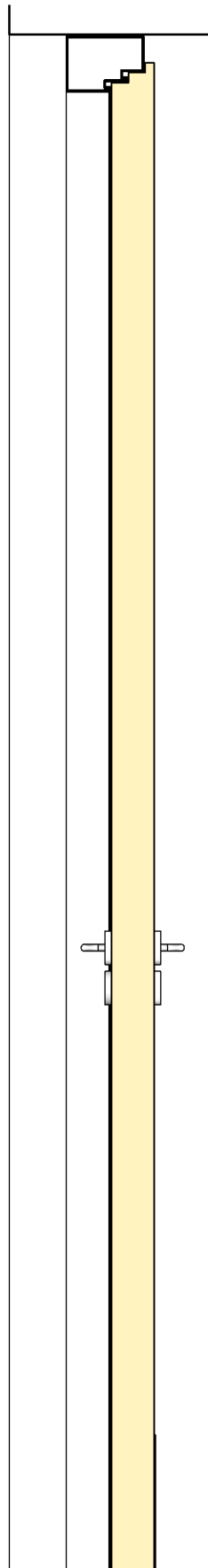

Frame Type 2
Section 2 Block Frame

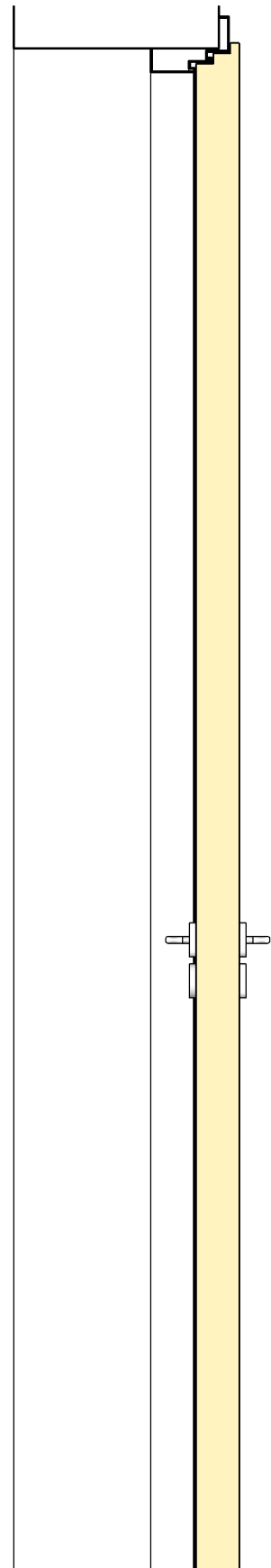

Frame Type 3
Section 3 Corner Frame

FIG 1

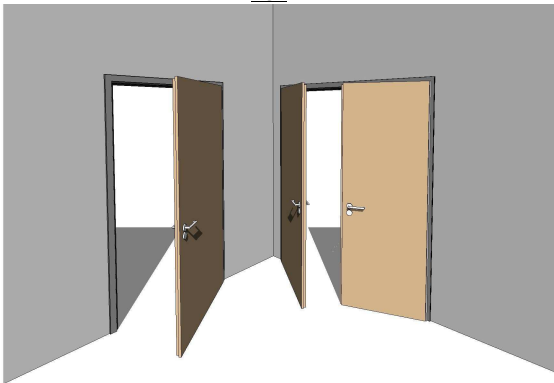

How To Create Double & Single Doors

In the Type Parameters under:-

Graphics

The tick box that needs to be selected is:-
DOUBLE DOOR

If the Tick Box **DOUBLE DOOR** is selected,
The Result is shown as a Double Swing Door as shown in **Fig 1**
If unselected, The Result is shown as a Single Swing Door as shown in **Fig 1**

Dimensions

You can specify and control the panel width with the Parameters **WIDTH SWING**.
This parameter lets you control the width of the Left panel when **DOUBLE DOOR** is selected,
When the width of the left panel is adjusted the right panel changes its width accordingly.
You can adjust the **WIDTH SWING** so that you have a result of the left panel to have an equal or greater width to the right panel.

Please Note when adjusting the **WIDTH** of the panel when double doors, the **WIDTH SWING** has to be adjusted accordingly as the value you put in for this parameter stays fix and the right panel adjusts to the remaining width of the clear **WIDTH** opening. The **WIDTH SWING** value needs to be more than 300mm.

The single door is adjusted by the parameter **WIDTH** and adjusts automatically to the width of the opening and the right door disappears

If **DOUBLE DOOR** is unselected which results in a single swing panel than the parameter **WIDTH SWING** does not need to be adjusted.

(PLEASE REFER TO DIMENSIONS OVERVIEW)

How To Create Single & Double Sliding Doors

In the Type Parameters under:-

Graphics

The tick box that needs to be selected is:-
SLIDING DOOR

If the Tick Box **SLIDING DOOR & DOUBLE DOOR** is selected the Result is shown as a Double Sliding Door as shown in **Fig 2**
If **DOUBLE DOOR** unselected, the result is shown as a Single Sliding Door as shown in **Fig 2**

Dimensions

The Additional parameters that you can control for the sliding doors are:-

SLIDING SWING PANEL OFFSET & SLIDING FIX PANEL OFFSET

These parameters let you control the amount of offset you require for the door to be within the cavity left & right. If the parameter is adjusted to zero, the door will be the same size as the opening width. If you adjust this parameter to 50mm, the door will have an offset of 50mm in to the cavity.

SLIDING DOOR SPACE SIDES

This parameter lets you control the space between the Door Panel and the Cavity. Adjusting this parameter to zero will result with no space, if adjusted to 5mm there will be a space of 5mm between the panel and the cavity.

SLIDING DOOR POSITION FROM INTERIOR

This parameter lets you control the position of the door from the interior.

You can create a door which is either on the internal surface of the wall just by adjusting this parameter to zero or have an offset to have the sliding doors center of the wall.

Please refer to page 4 of 15 **Plan View** By adjusting the parameter **FRAME DEPTH POSITION FROM INTERIOR** you can create the position of the sliding door to flush with the interior of the wall or have the position on the external surface of the wall.

Please note that the parameter **WIDTH SWING** adjust when Sliding Door & Double Door is activated

(PLEASE REFER TO DIMENSIONS OVERVIEW)

FIG 2

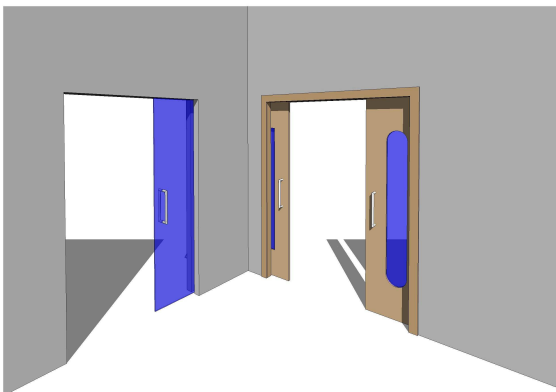

FIG 3



How To Create Transom Window & Side Lights

In the Type Parameters under:-

Graphics

The tick boxes that need to be selected are:-
SIDE LIGHT LEFT VISIBILITY, SIDE LIGHT RIGHT VISIBILITY & TRANSOM WINDOW VISIBILITY

If the Tick Box **SIDE LIGHT LEFT VISIBILITY, SIDE LIGHT RIGHT VISIBILITY & TRANSOM WINDOW VISIBILITY** are selected,
The Result is shown as **Fig 3**
If unselected, The Result is shown without any Sidelight or Transom.

Dimensions

The Additional parameters that you can control for the Side Lights and Transom Window are:-

SIDE LIGHT & TRANSOM INTEGRATED

If selected, this Parameter allows you to have a Side Light which has a separate frame from the door to a integrated frame to the door.

SIDE LIGHT SILL VISIBILITY

This parameter lets you control the visibility of the internal & external sill.

The parameters for these sills are explained below

SIDE LIGHT SILL BOTTOM HEIGHT OFFSET

This parameter lets you control the height of the Side Light Sills

SIDE LIGHT & TRANSOM FRAME WIDTH

SIDE LIGHT LEFT WIDTH, SIDE LIGHT RIGHT WIDTH & TRANSOM HEIGHT

SIDE LIGHT EXTERNAL SILL PLATE HEIGHT

SIDE LIGHT EXTERNAL SILL DEPTH

SIDE LIGHT EXTERNAL SILL ANGLE

SIDE LIGHT INTERNAL SILL HEIGHT

SIDE LIGHT INTERNAL SILL DEPTH

(PLEASE REFER TO DIMENSIONS OVERVIEW)

Openings

The parameters **DOOR OPENING LEFT & SINGLE** is for the left door as shown in

Dimensions overview page 2 of 15

When you untick **DOUBLE DOOR** the result is a Left single swing door which the parameter **DOOR OPENING LEFT & SINGLE** is used for.

To create a Right single swing door, there is a flip control switch as shown In plan. This will flip the Door to give a result of a Right single swing door which the same parameter is used to open and close the swing door.

The parameters **DOOR OPENING RIGHT** is for the Right door. When you tick **DOUBLE DOOR** the result is a Right swing door which the parameter **DOOR OPENING RIGHT** is used for

Please note that these parameters are not angle parameters but are integer percentage parameters.

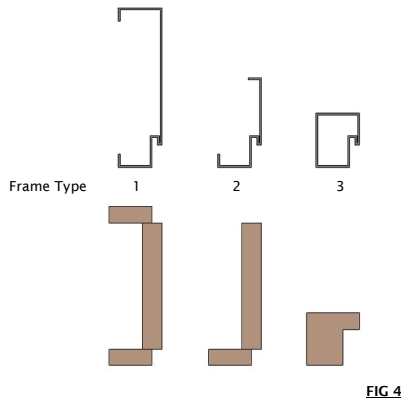

FIG 4

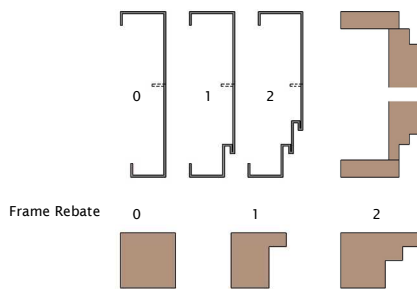

FIG 5

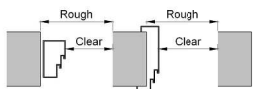

FIG 6

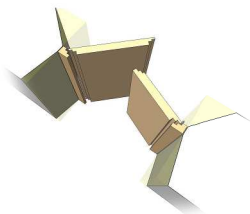

FIG 7

FIG 8

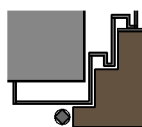
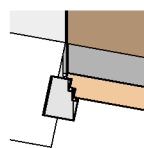
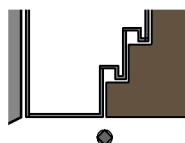

FIG 9

FIG 10



How To Create Frame Types & Frame Rebates

In the Type Parameters under:-

Constraints

To change the Frame Type or Frame Rebate the parameters are:-
FRAME TYPE & FRAME REBATE

The *FRAME TYPE* has 3 Types as shown in Fig 4

Frame Type 1= Closure Frame
Frame Type 2= Corner Frame
Frame Type 3= Block Frame

Frame Type 1 which is a Closure Frame, closes the depth of the wall or can be flush with the wall on the interior and exterior. The Parameter which controls the positions are:- *FRAME DEPTH POSITION INTERIOR & FRAME DEPTH POSITION EXTERIOR* Please refer to page 4 of 15 Plan View. By adjusting the parameter *FRAME DEPTH POSITION FROM INTERIOR*. You can have a negative value which results in the frame adjusting outwards, or have a zero value to have the frame flush with the walls, or have a positive value which results in the frame adjusting inwards.

Frame Type 2 which is a Corner Frame sits on the Interior corner of the wall

Frame Type 3 which is a Block Frame sits anywhere in the middle of the wall. The Parameter which controls the position of the Block Frame is *FRAME DEPTH POSITION INTERIOR*

The *FRAME REBATE* can have up to 2 Rebates as shown in Fig 5

Frame Rebate 0 = No Rebate
Frame Rebate 1 = One Rebate
Frame Rebate 2 = Two Rebates

The Frame Rebates can be used along with all frame types apart from the Sliding Doors which automatically adjust to Frame Type 1 and the Side Lights setups and Transom window automatically adjust to Frame Type 3.

These Frame Types can be adjusted to either Wood Frame or Metal with a click of a button enabling *WOOD FRAME*

All parameters for frame types, frame rebates and positioning have the same parameters for both Wood frame & Metal frames

(PLEASE REFER TO DIMENSIONS OVERVIEW)

Rough Distance

In the Type Parameters under:-

Dimensions

To Have a Rough Distance from the Clear Width the parameters are:-

ROUGH DISTANCE LEFT, ROUGH DISTANCE RIGHT, ROUGH DISTANCE BOTTOM, ROUGH DISTANCE TOP, ROUGH DISTANCE BOTTOM INSTANCE
All These parameters can be adjusted separately as shown in Fig 6

Rough distance on each side is from the clear opening Width or Height as Shown in Dimensions overview page 2 of 15

This has to be manually adjusted. if you have a situation where you cannot see the frame, this is probably because the Rough Distance is set to zero. If you do not want the frame visible, there is a parameter which is called *FRAME VISIBILITY*. Unselect this tick box and adjust the Rough Distance on all sides to be 0 or a desired value

ROUGH DISTANCE BOTTOM is type related parameter for all types. *ROUGH DISTANCE BOTTOM INSTANCE* is related to one instance. Both Parameters have the same function. To extend the Bottom opening of the door for varying floor thicknesses you can adjust either parameters for one instance or all types.

(PLEASE REFER TO DIMENSIONS OVERVIEW)

How To Create Tapered Reveals & Render Offsets

In the Type Parameters under:-

Dimensions

To Have Tapered Reveals the parameters are:-

TAPER REVEAL INTERIOR LEFT, TAPER REVEAL INTERIOR RIGHT, TAPER REVEAL EXTERIOR LEFT, TAPER REVEAL EXTERIOR RIGHT, TAPER REVEAL INTERIOR TOP, TAPER REVEAL EXTERIOR TOP.

All parameters can be adjusted separately as shown in Fig 7

To Have Render Offset the parameters are:-

RENDER OFFSET SIDES INTERIOR, RENDER OFFSET SIDES EXTERIOR, RENDER OFFSET TOP INTERIOR, RENDER OFFSET TOP EXTERIOR.
as shown in Fig 8

Please note that the positioning of the frame will affect the reveals adjusting

These parameters also can be used on a joined wall Please refer to page 13 of 15 Fig 12 and notes

(PLEASE REFER TO DIMENSIONS OVERVIEW)

Hinges

The Hinge Position automatically disappear when Sliding Door is activated. When *DOOR FLUSH* is selected the Hinge Position is automatically adjusted to the center of the space between the door and the Frame as shown in Fig 10.

When Door Flush is deactivated the Hinge Position repositions itself to the side of the panel which offsets from the frame and center as shown in Fig 9. The panel offset can be adjusted by using the parameter *PANEL FRAME OFFSET* only when the parameter *DOOR FLUSH* is not selected. These parameters can be adjusted in any Door setup

In the Type Parameters under:-

Dimensions

To Adjust Hinges the parameters are:-
HINGE RADIUS, HINGE OFFSET

(PLEASE REFER TO DIMENSIONS OVERVIEW)

Door Flush & not Flush

Graphics

When *DOOR FLUSH* is Selected as shown in Fig 10

When *DOOR FLUSH* is Deselected as shown in Fig 9

(PLEASE REFER TO DIMENSIONS OVERVIEW)

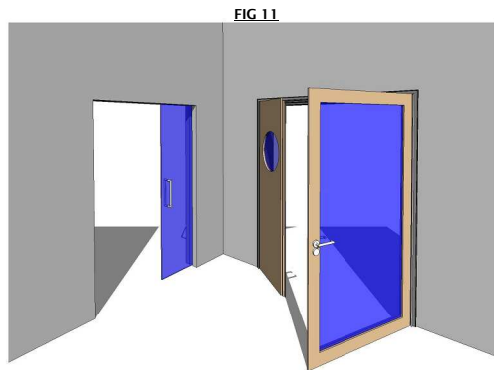

FIG 11

How To Create Panel Glazing

In the Type Parameters under:-

Graphics

To Create Panel Glazing, The parameters are:-
PANEL GLAZING VISIBILITY LEFT , *PANEL GLAZING VISIBILITY RIGHT*
When both Parameters are selected the result is shown as Fig 11

Dimensions

Each door has its own parameters to adjust the Panel Glazing frame thickness and the radius for each corner of the panel frame
The Parameters for the Left Door are:-

SWING PANEL FRAME BOTTOM THICKNESS, *SWING PANEL HINGE SIDE THICKNESS*,
SWING PANEL MIDDLE SIDE THICKNESS, *SWING PANEL TOP THICKNESS*
SWING PANEL RADIUS HINGE SIDE TOP, *SWING PANEL RADIUS HINGE SIDE BOTTOM*,
SWING PANEL RADIUS MIDDLE SIDE TOP , *SWING PANEL RADIUS MIDDLE SIDE BOTTOM*

The Parameters for the Right Door are:-

FIX PANEL FRAME BOTTOM THICKNESS, *FIX PANEL HINGE SIDE THICKNESS*,
FIX PANEL MIDDLE SIDE THICKNESS, *FIX PANEL TOP THICKNESS*
FIX PANEL RADIUS HINGE SIDE TOP, *FIX PANEL RADIUS HINGE SIDE BOTTOM*,
FIX PANEL RADIUS MIDDLE SIDE TOP & *FIX PANEL RADIUS MIDDLE SIDE BOTTOM*

To Create a door which is a fully glazed door without frames. switch off the parameters *PANEL GLAZING VISIBILITY LEFT* & *PANEL GLAZING VISIBILITY RIGHT* and set the door thickness to atleast 12mm & change the material from Wood to Glass as shown as Fig 11

(PLEASE REFER TO DIMENSIONS OVERVIEW)

Void For Additional Walls

In the Type Parameters under:-

Dimensions

If you need to add an additional Wall (e.g Dry-Lining) to join with the original wall. Create a new basic wall, change the properties as your specification and join the to original wall.
To cut the new additional wall that has been added either to the interior or exterior of the original wall, adjust the parameters:-

VOID INTERIOR OFFSET or *VOID EXTERIOR OFFSET* to the thickness of the additional new wall added, the result will be a cut out of the new wall as shown in Fig 12

Please note that all parameters for tapered reveals and render offset can apply to new additional walls when the void is offsetted

(PLEASE REFER TO DIMENSIONS OVERVIEW)

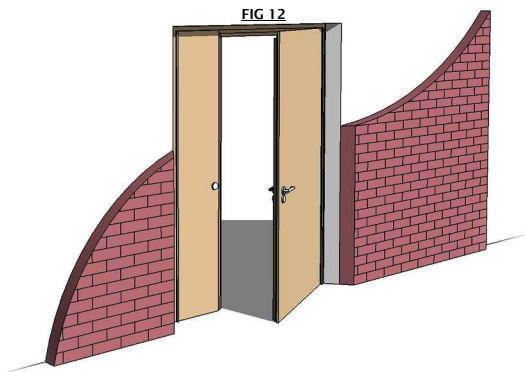

FIG 12

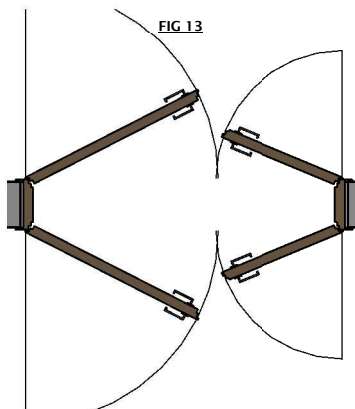

FIG 13

How To Create Double Panel

In the Type Parameters under:-

Graphics

You can setup a Double Panel Door for the Single and Double Swing Door as you might need for Hotel or Office Project where noise reduction is a subject. To Create Double Panel, The parameters are:-

DOUBLE PANEL VISIBILITY as shown as Fig 13

(PLEASE REFER TO DIMENSIONS OVERVIEW)

How To Create Symbol Lines

In the Type Parameters under:-

Constraints

To Create Symbol Lines select the parameters in the instance properties box *SYMBOL LINES* the result will be Fig 14 & 15

All Symbol Lines will appear in Plan & Elevations

To have symbol lines adjusted to your local standards, showing the opposite side in elevation, adjust the parameter *SYMBOL LINES FROM HINGE SIDE* the result will show the symbol lines flipped only in elevation on the opposite side as shown in Fig 15

To Have Symbol Lines adjusting in plan view, select the parameter *SYMBOL LINES OPENING ANGLE SYNC*.

The symbol lines will adjust with the Parameters:-
DOOR OPENING LEFT & *SINGLE* and *DOOR OPENING RIGHT*

If the parameter *SYMBOL LINES OPENING ANGLE SYNC* is unselected, the symbol lines will not adjust with the parameters *DOOR OPENING LEFT* & *SINGLE* and *DOOR OPENING RIGHT*.

They can be manually adjusted with the parameters under the Dimensions called *SYMBOL LINES OPENING ANGLE RIGHT* & *SYMBOL LINES OPENING ANGLE LEFT*.

The Symbol lines will remain static at the position you require once adjusting, while you adjust the doors to a close position or a angle that you specify as shown in Fig 13

Please note that these symbol lines are shown in Coarse, Medium & Fine Modes and are ideally used in plan view with or without the Doors Visibility.

To switch off the Doors Visibility , under Graphics unselect the parameter *DOORS VISIBILITY*.

All doors for that type will be switched of and you will remain with the symbol lines showing.

To switch of the symbol lines simply unselect the *SYMBOL LINES* parameter under Graphics, all Symbol lines will turn off.

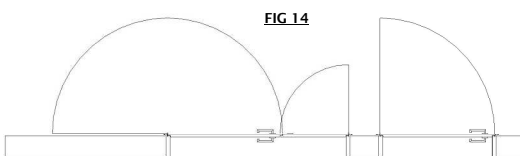

FIG 14

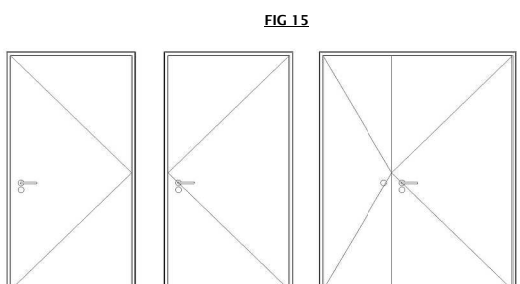
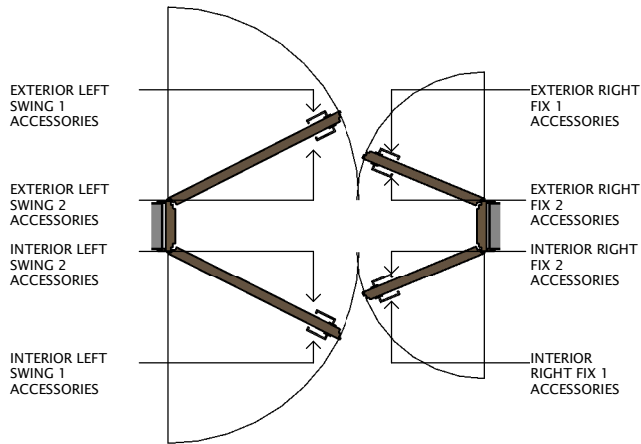

FIG 15

Door Accessories



In the Type Parameters under:-

Dimensions

All The accessories have Dimensions and are stated as below

Door Knob Handle

Door Handle 1 Length
Door Handle 1 Width
Door Handle 1 Depth
Door Handle 1 Radius

Door Lever Handle

Door Handle 2 Width
Door Handle 2 Depth
Door Handle 2 Depth 2
Door Handle 2 Radius
Door Handle 2 Angle
Door Handle 2 Height Postion

Door Lock

Door Lock Length
Door Lock Width
Door Lock Depth
Door LockRadius
Door Lock Height Position

Kick Plate

Kickplate Side Offset
Kickplate Height
Kickplate Thickness
Kickplate Bottom Offset

Door Handle Height Position
Door Handle Position From Sides

(PLEASE REFER TO DIMENSIONS OVERVIEW)

In the Instance Parameters under:-

Constraints

INTERIOR LEFT SWING 1 ACCESSORIES, INTERIOR LEFT SWING 2 ACCESSORIES, INTERIOR RIGHT FIX 1 ACCESSORIES, INTERIOR RIGHT FIX 2 ACCESSORIES
EXTERIOR LEFT SWING 1 ACCESSORIES, EXTERIOR LEFT SWING 2 ACCESSORIES, EXTERIOR RIGHT FIX 1 ACCESSORIES, EXTERIOR RIGHT FIX 2 ACCESSORIES

Each Integer parameter has the same visibility configuration on each sides of the door panels. When adjusting the integer parameter from 0 - 10 the results are the following:-

(PLEASE REFER TO DIMENSIONS OVERVIEW)

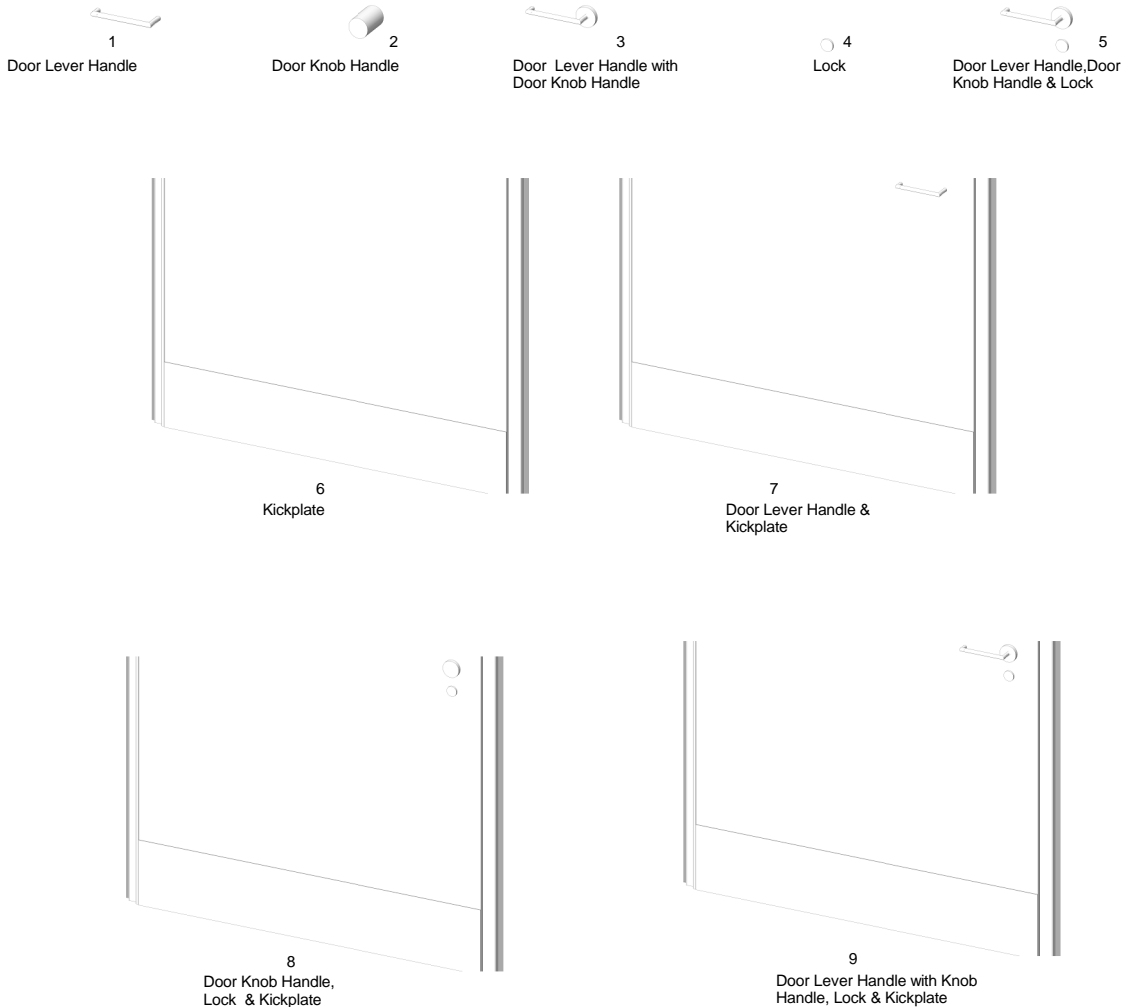

FIG 16

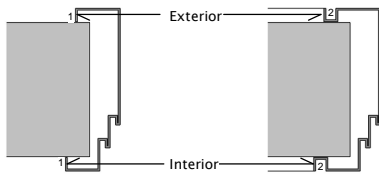

FIG 17

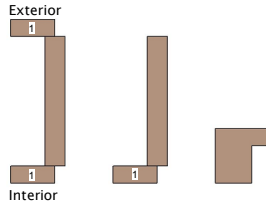

FIG 18

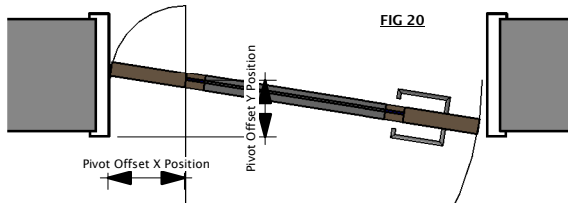
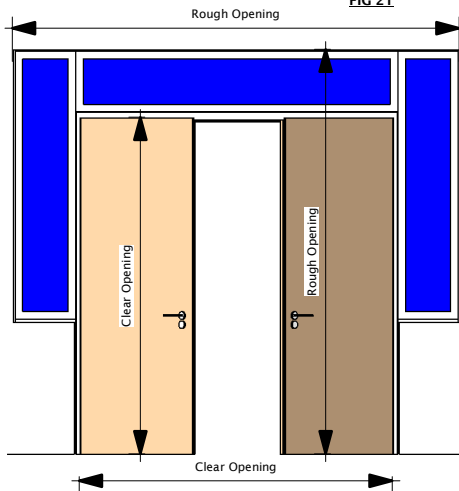

FIG 21



Frame Fold Interior & Frame Fold Exterior

In the Type Parameters under:-

Graphics

To Create Frame Folds, The parameters are:-
FRAME FOLD INTERIOR & FRAME FOLD EXTERIOR

Each Integer parameter has the same visibility configuration on each sides.
When adjusting the integer parameter from 0 - 2 the results are the following:-

Metal Frame

FRAME FOLD INTERIOR

- 0 = No Fold
- 1 = Fold
- 2 = Shadow Gap

FRAME FOLD EXTERIOR

- 0 = No Fold
- 1 = Fold
- 2 = Shadow Gap

Wood Frame

FRAME FOLD INTERIOR

- 0 = No Fold
- 1 = Interior Architrave

FRAME FOLD EXTERIOR

- 0 = No Fold
- 1 = Exterior Architrave

(PLEASE REFER TO DIMENSIONS OVERVIEW)

Clear Opening

In the Type Parameters under:-

Graphics

To Adjust the opening, The parameter is:-
CLEAR OPENING

If Selected The Parameter Height & Width represents the Clear Opening
If Unselected The Parameter Height & Width represents the Rough Opening

When selecting the parameter *CLEAR OPENING* , the results is:-
The Clear opening of the Height & Width of the door as shown in
Fig 20 & Fig 21

When unselecting the parameter *CLEAR OPENING*
The result is Rough Opening of the Height & Width as shown in
Fig 20 & Fig 21

Please note that the dimension line in plan view which has the option of
showing the height as well as the width, represents the value of the height
when the parameter is selected and unselected to show the result of the Clear
Height & Width or the Rough Opening Height & Width

(PLEASE REFER TO DIMENSIONS OVERVIEW)

Pivot Position Offset

In the Type Parameters under:-

Graphics

To Adjust the opening, The parameter is:-
PIVOT POSITION OFFSET

When selecting the parameter *PIVOT POSITION OFFSET*, the results is
shown in Fig 20

Dimensions

- Pivot Offset X Position
- Pivot Offset Y Position

(PLEASE REFER TO DIMENSIONS OVERVIEW)

REVISION 5

Our new Revised family now has the advanced option to have a Groove or No Groove as Well as Double Rebate. These options can be adjusted with selecting the parameter "GROOVE" or "DOUBLE REBATE"
The "DOUBLE REBATE" is only activated when the Metal frame is activated and Frame Type 1 is selected as shownn in FIG 22 & 23

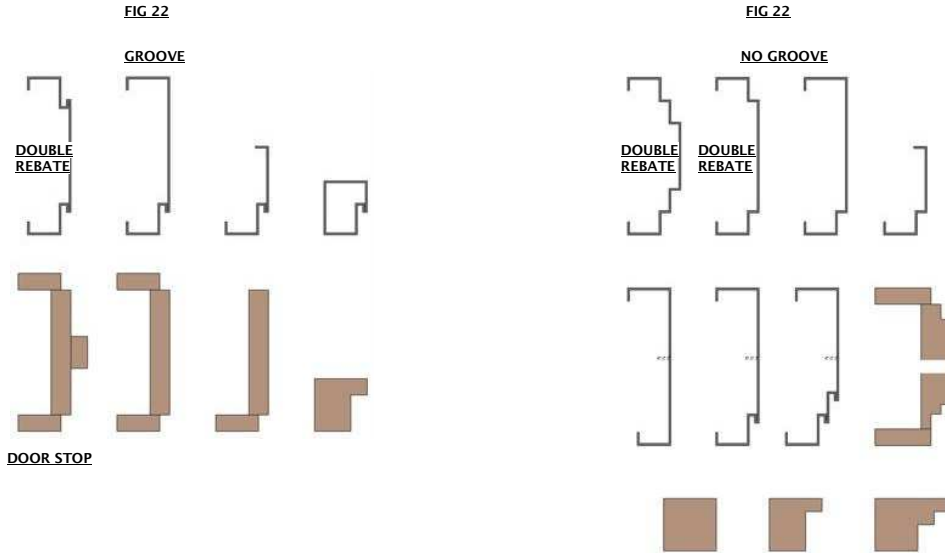

We have also included now a Door Stop for the Wood frame. This is also controlled by selecting the Parameter "DOOR STOP"
This is only activates when the Wood frame is activated and Frame Type 1 is selected as shownn in FIG 22

As well as these option we have now introduced a Metal Anchor which as shownn in FIG 23 the can be controlled by a length parameter called Metal Anchor Length. When yero the visibility will switch off

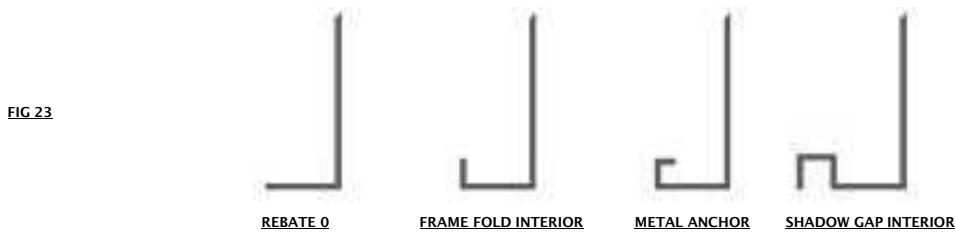

REVISION 5

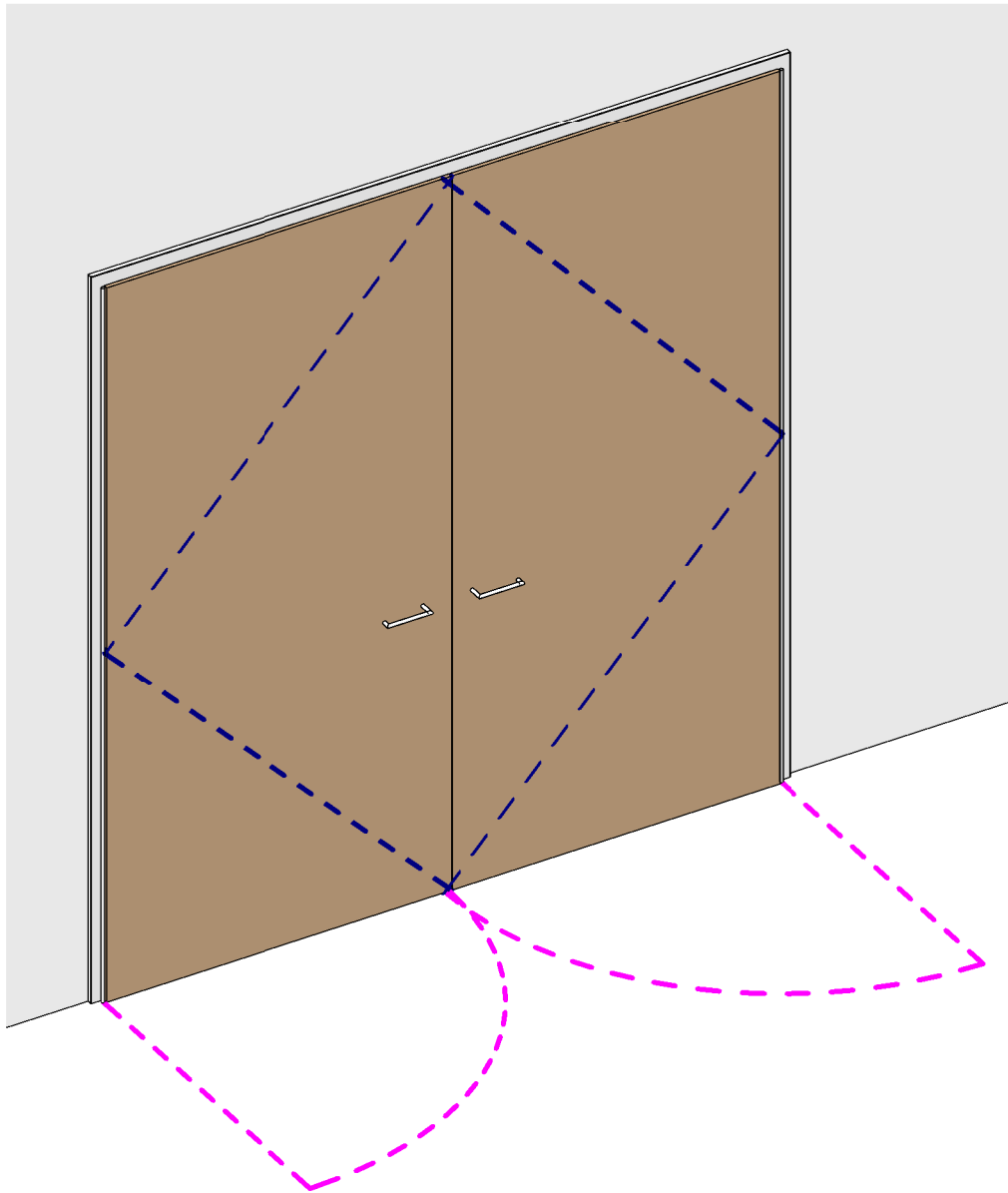

3D SYBOL LINES

Our new Revised family now has the advanced option to have 3D Symbol Lines as well as 2D Symbol Lines. These options can be adjusted with selecting the parameter "2D SYMBOL LINES" or "3D SYMBOL LINES" under the Graphics Menu

The 2D SYMBOL LINES Can only be viewed in Plan & Elevation, the 3D SYMBOL LINES Show in all views

REVISION 6

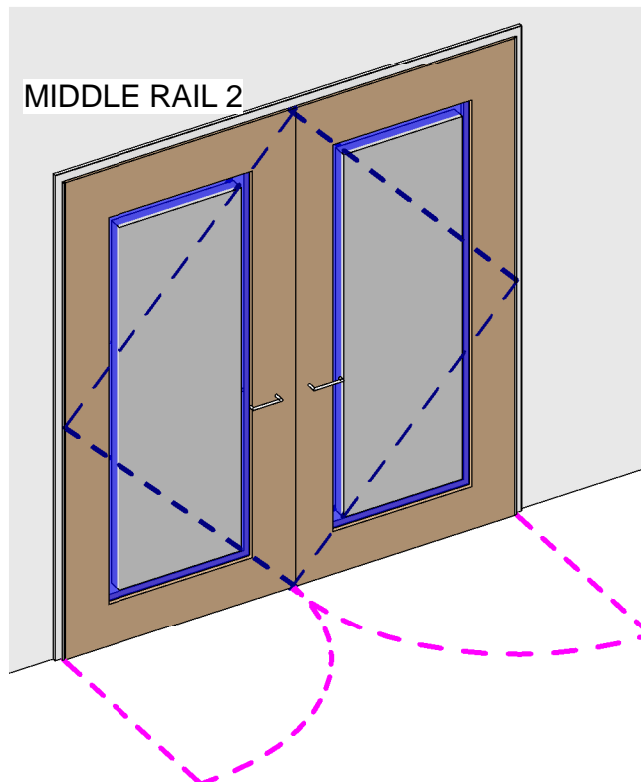
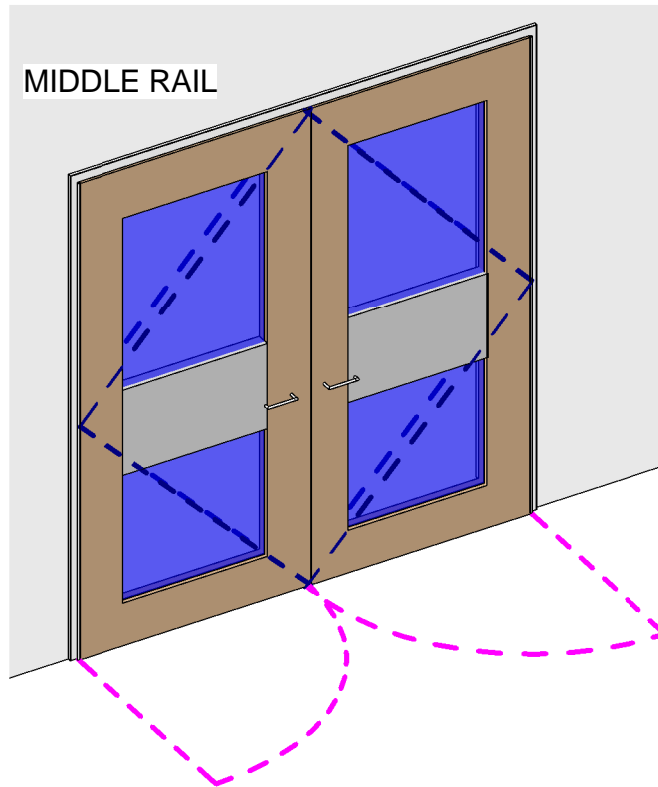

Our new Revised family now has the advanced option to have a middle rail which can be setup to different configurations as shown above. These options can be adjusted with selecting the parameter "MIDDLE RAIL" under the Graphics Menu

The Middle Rail has 3 Parameters which can be adjusted to have the configuration that you need. These parameters are called: "MIDDLE RAIL HEIGHT", "MIDDLE RAIL SIDE OFFSET" & "MIDDLE RAIL HEIGHT POSITION"

Please note that the position of the Middle Rail is offsetted from the Door Panel Frame

REVISION 7

Threshold

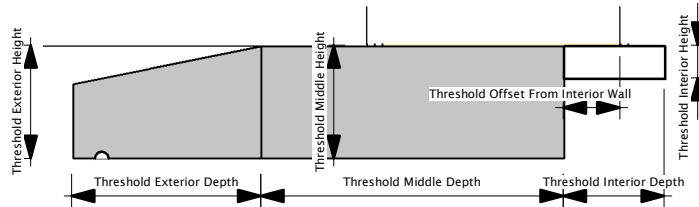

Exterior

Interior

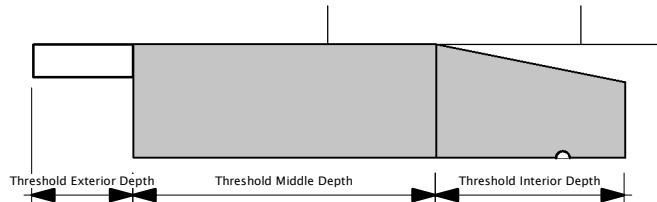

In the Type Parameters under:-

Graphics

The parameter are

THRESHOLD VISIBILITY INTERIOR

- 0 = No Threshold
- 1 = Solid Sill
- 2 = Stone Sill
- 3 = Metal Sill

THRESHOLD VISIBILITY EXTERIOR

- 0 = No Threshold
- 1 = Solid Sill
- 2 = Stone Sill
- 3 = Metal Sill

THRESHOLD VISIBILITY MIDDLE

Dimensions

- Threshold Height Position Offset
- Threshold Offset From Interior Wall
- Threshold Middle Depth
- Threshold Exterior Depth
- Threshold Interior Depth
- Threshold Middle Height
- Threshold Exterior Height
- Threshold Interior Height
- Threshold Offset Left
- Threshold Offset Right

(PLEASE REFER TO DIMENSIONS OVERVIEW)

Our new Revised family now has the advanced option to have a Threshold which can be setup to different configurations. If the Door Family is flipped you now have the option to switch between the sills with the integer parameters, so you can swap the sills to be on the opposite sides or have the same sills on each side. Please note that the position of the Middle Rail is offsetted from the Door Panel Frame