

No	Parameters	Page	Type
Constraints			
1	Exterior Left Swing 1 Accessories	16	Integer - Instance
2	Exterior Left Swing 2 Accessories	16	Integer - Instance
3	Exterior Right Fix 1 Accessories	16	Integer - Instance
4	Exterior Right Fix 2 Accessories	16	Integer - Instance
5	Interior Left Swing 1 Accessories	16	Integer - Instance
6	Interior Left Swing 2 Accessories	16	Integer - Instance
7	Interior Right Fix 1 Accessories	16	Integer - Instance
8	Interior Right Fix 2 Accessories	16	Integer - Instance
9	Fix Panel Flip	11	Yes/No - Type
10	Fix Panel Opening%	11	Integer - Type
11	Frame Type	5	Integer - Type
12	Frame Rebate	6	Integer - Type
13	Fix Panel Horizontal Glazing Bar Count	13	Integer - Type
14	Fix Panel Vertical Glazing Bar Count	13	Integer - Type
15	Kickplate Visibility	12	Yes/No - Instance
16	Sliding Door Symbol Lines Depth Position	15	Length - Instance
17	Swing Panel Flip	11	Yes/No - Type
18	Swing Panel Horizontal Glazing Bar Count	13	Integer - Type
19	Swing Panel Vertical Glazing Bar Count	13	Integer - Type
20	Swing Panel Opening%	11	Integer - Type
21	Symbol Line Opening Angle Left %	15	Integer - Instance
22	Symbol Line Opening Angle Right %	15	Integer - Instance
23	Symbol Lines 2D	15	Yes/No - Instance
24	Symbol Lines 3D	15	Yes/No - Instance
Graphics			
25	Door Flush	7,8,9,10,11	Yes/No - Type
26	Door Stop Visibility	9	Yes/No - Type
27	Double Door	1	Yes/No - Type
28	Double Panel Visibility	11	Yes/No - Type
29	Double Rebate	6,9	Yes/No - Type
30	Fix Panel Glazing Visibility	12	Yes/No - Type
31	Fold Exterior	6,7,8,9,10	Integer - Type
32	Fold Interior	6,7,8,9,10	Integer - Type
33	Frame Visibility	1,2	Yes/No - Type
34	Groove Visibility	7,8,9,10	Yes/No - Type
35	Middle Rail Visibility	14	Yes/No - Type
36	Side & Transom Integrated	3	Yes/No - Type
37	Side Light Right Visibility	3	Yes/No - Type
38	Side Light Left Visibility	3	Yes/No - Type
39	Side Light Sill Visibility	3	Yes/No - Type
40	Size Type	5	Integer - Type
41	Swing Panel Glazing Visibility	12	Yes/No - Type
42	Symbol Lines Hinge Side	15	Yes/No - Type
43	Threshold Visibility Exterior	17	Yes/No - Type
44	Threshold Visibility Interior	17	Yes/No - Type
45	Threshold Visibility Middle	17	Yes/No - Type
46	Transom Window Visibility	3	Yes/No - Type
47	Wood Frame	1,7,8,9,10	Yes/No - Type
Dimensions			
48	Height	5	Length - Type
49	Width	5	Length - Type
50	Width Swing	5	Length - Type
51	Width Fix	5	Length - Type
52	Door Stop Width	9	Length - Type
53	Door Stop Depth	9	Length - Type
54	Door Stop Position	9	Length - Type
55	Door Glass Position From Exterior	12,13	Length - Type
56	Door Glass Thickness	12,13	Length - Type
57	Door Handle Height Position	3,15	Length - Type
58	Door Handle Position From Sides	16	Length - Type
59	Door Knob Or Plate Depth	16	Length - Type
60	Door Knob Or Plate Height	16	Length - Type
61	Door Knob Or Plate Radius	16	Length - Type
62	Door Knob Or Plate Width	16	Length - Type
63	Door Lever Handle Angle	16	Angle -Type
64	Door Lever Handle Depth 2	16	Length - Type
65	Door Lever Handle Depth 1	16	Length - Type
66	Door Knob Or Plate Height Position	16	Length - Type
67	Door Lever Handle Width	16	Length - Type
68	Door Lever Handle Profile Radius	16	Length - Type
69	Door Lever Handle Profile Width	16	Length - Type
70	Door Lock Depth	16	Length - Type
71	Door Lock Height Position	16	Length - Type
72	Door Lock Height	16	Length - Type
73	Door Lock Radius	16	Length - Type
74	Door Lock Width	16	Length - Type
75	Door Thickness	2,7,10,12,13	Length - Type
76	Fix Glazing Bottom Offset	12	Length - Type
77	Fix Glazing Hinge Offset	12	Length - Type
78	Fix Glazing Middle Offset	12	Length - Type
79	Fix Glazing Top Offset	12	Length - Type
80	Fix Glazing Radius Hinge Bottom	12	Length - Type
81	Fix Glazing Radius Hinge Top	12	Length - Type
82	Fix Glazing Radius Middle Bottom	12	Length - Type
83	Fix Glazing Radius Middle Top	12	Length - Type
84	Frame Depth Position Exterior	8,9,10	Length - Type
85	Frame Depth Position Interior	7,8,9,10	Length - Type
86	Frame Depth 3	7	Length - Type

No	Parameters	Page	Type
Dimensions			
87	Frame Metal Fold Depth Exterior	8,9,10	Length - Type
88	Frame Metal Fold Depth Interior	8,9,10	Length - Type
89	Frame Metal Groove Depth	7,8	Length - Type
90	Frame Metal Groove Width	7,8	Length - Type
91	Frame Metal Anchor Length	7,8,9,10	Length - Type
92	Frame Metal Shell Thickness	7,8,9,10	Length - Type
93	Frame Rebate Width 1	7,8,9,10	Length - Type
94	Frame Rebate Width 2	7,8,9,10	Length - Type
95	Frame Rebate Depth 1	7,8,9,0	Length - Type
96	Frame Rebate Depth 2	7,8,9,10	Length - Type
97	Frame Shadow Gap Depth	8,9	Length - Type
98	Frame Shadow Gap Width	8,9	Length - Type
99	Frame Width Exterior	8,9	Length - Type
100	Frame Width Interior	7,8,9,10	Length - Type
101	Frame Wood Depth Interior & Exterior	8,9,10	Length - Type
102	Frame Wood Exterior Sides Offset	8,9,10	Length - Type
103	Frame Wood Interior Sides Offset	8,9,10	Length - Type
104	Frame Wood Middle Width	7,8,9,10	Length - Type
105	Glazing Bar Depth	13	Length - Type
106	Glazing Bar Width	13	Length - Type
107	Hinge Offset X Position	7,8,9,10	Length - Type
108	Hinge Offset Y Position	7,8,9,10	Length - Type
109	Hinge Radius	7,8,9,10	Length - Type
110	Kick Plate Height	12	Length - Type
111	Kick Plate Thickness	12	Length - Type
112	Middle Rail Bottom Offset	14	Length - Type
113	Middle Rail Middle Side Offset	14	Length - Type
114	Middle Rail Hinge Side Offset	14	Length - Type
115	Middle Rail Top Offset	14	Length - Type
116	Pivot Offset Y Position	11	Length - Type
117	Pivot Offset X Position	11	Length - Type
118	Render Offset Sides Exterior	4,7	Length - Type
119	Render Offset Sides Interior	4,7	Length - Type
120	Render Offset Top Exterior	4	Length - Type
121	Render Offset Top Interior	4	Length - Type
122	Render Wrap Exterior Offset	4	Length - Type
123	Render Wrap Interior Offset	4	Length - Type
124	Rough Distance Bottom	3,4,5	Length - Type
125	Rough Distance Bottom Instance.	3,4,5	Length - Instance
126	Rough Distance Left	3,4,7,8,9,10	Length - Type
127	Rough Distance Right	3,4,7,8,9,10	Length - Type
128	Rough Distance Top	3,4	Length - Type
129	Side Light & Transom Frame Width	3	Length - Type
130	Side Light External Sill Angle	3	Length - Type
131	Side Light External Sill Depth	3	Length - Type
132	Side Light Internal Sill Height	3	Length - Type
133	Side Light Left Width	3	Length - Type
134	Side Light Right Width	3	Length - Type
135	Side Light Sill Bottom Offset Height	3	Length - Type
136	Side Light Sill External Plate Height	3	Length - Type
137	Side Light Sill Internal Sill Depth	3	Length - Type
138	Sliding Door Position From Interior	2	Length - Type
139	Sliding Door Space Sides	2	Length - Type
140	Sliding Door Top Height Offset	2	Length - Type
141	Sliding Fix Panel Offset	2	Length - Type
142	Sliding Swing Panel Offset	2	Length - Type
143	Space	7,8,9,10	Length - Type
144	Space 2	7,8,9,10	Length - Type
145	Swing Glazing Bottom Offset	12	Length - Type
146	Swing Glazing Hinge Offset	12	Length - Type
147	Swing Glazing Middle Offset	12	Length - Type
148	Swing Glazing Top Offset	12	Length - Type
149	Swing Glazing Radius Hinge Bottom	12	Length - Type
150	Swing Glazing Radius Hinge Top	12	Length - Type
151	Swing Glazing Radius Middle Bottom	12	Length - Type
152	Swing Glazing Radius Middle Top	12	Length - Type
153	Taper Reveal Exterior Left	4	Length - Type
154	Taper Reveal Exterior Right	4	Length - Type
155	Taper Reveal Exterior Top	4	Length - Type
156	Taper Reveal Interior Left	4	Length - Type
157	Taper Reveal Interior Right	4	Length - Type
158	Taper Reveal Interior Top	4	Length - Type
159	Threshold Height Position Offset	17	Length - Type
160	Threshold Offset From Interior Wall	17	Length - Type
161	Threshold Exterior Height	17	Length - Type
162	Threshold Interior Height	17	Length - Type
163	Threshold Offset Left	17	Length - Instance
164	Threshold Offset Right	17	Length - Instance
165	Threshold Middle Height Position	17	Length - Type
166	Threshold Middle Height	17	Length - Type
167	Threshold Exterior Depth	17	Length - Type
168	Threshold Interior Depth	17	Length - Type
169	Threshold Middle Depth	17	Length - Type
170	Threshold Front Height	17	Length - Type
171	Transom Height	4	Length - Type
172	Undercut Height	4,5	Length - Type
173	Void Exterior Offset	4	Length - Type
174	Void Interior Offset	4	Length - Type

Metal - Wood

Double - Single

Swing - Sliding

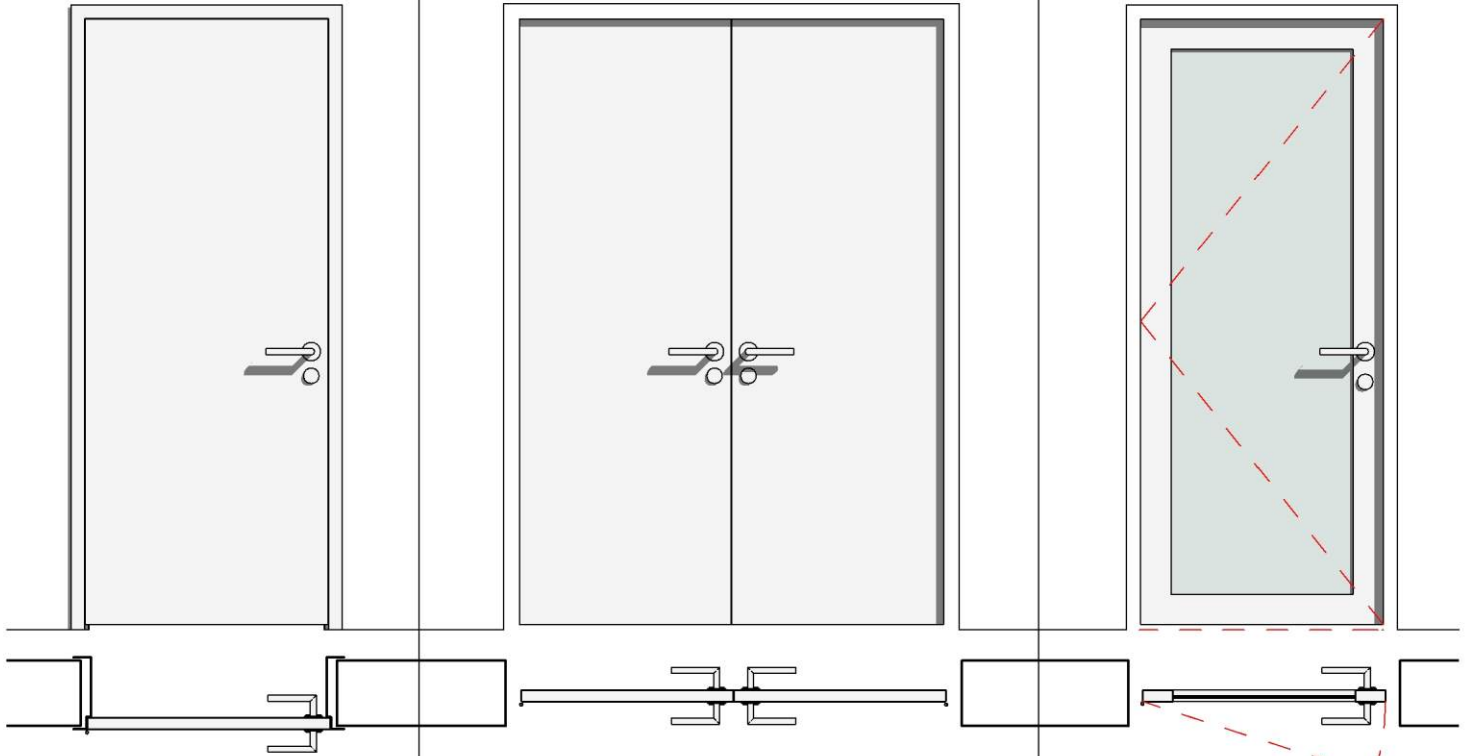

Wood Frame
 Frame Visibility

Double Door
 Frame Visibility

Sliding Door
 Frame Visibility

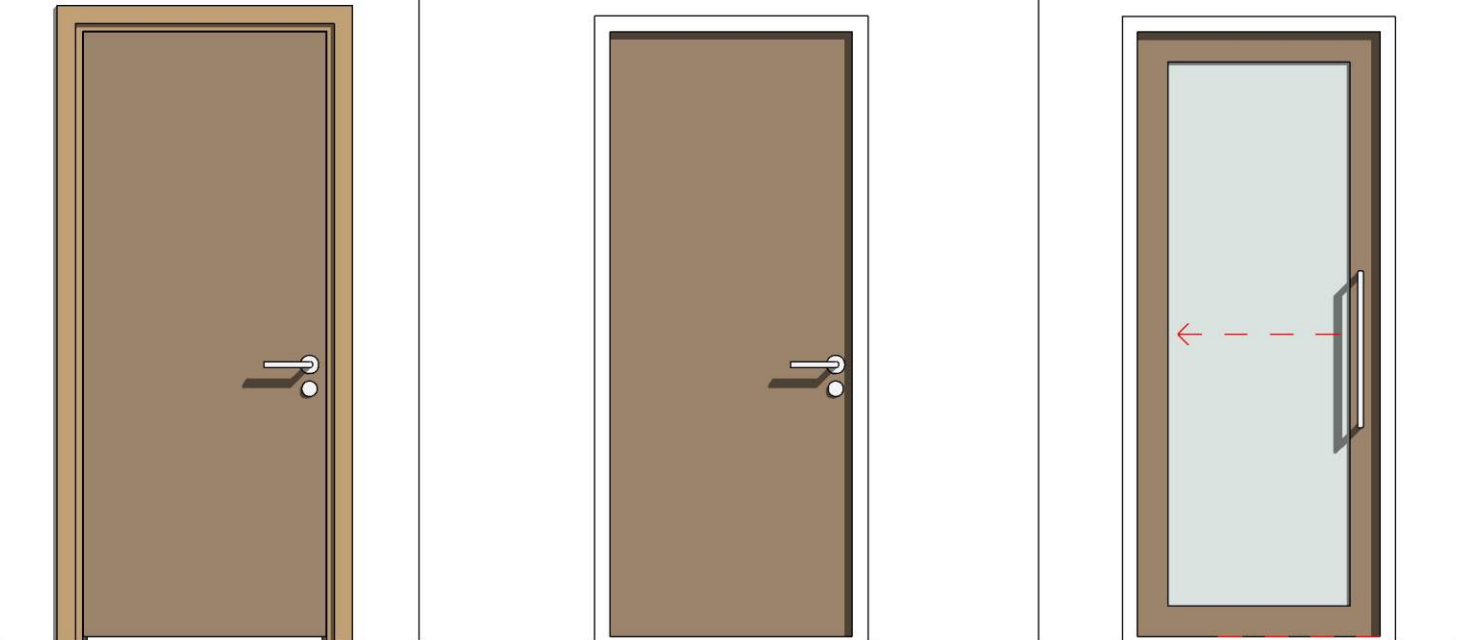

Wood Frame
 Frame Visibility

Double Door
 Frame Visibility

Sliding Door
 Frame Visibility

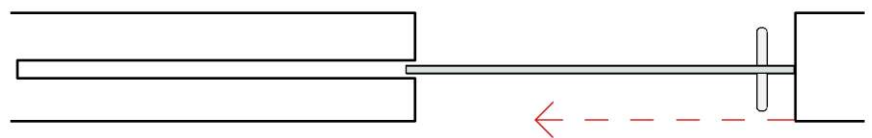
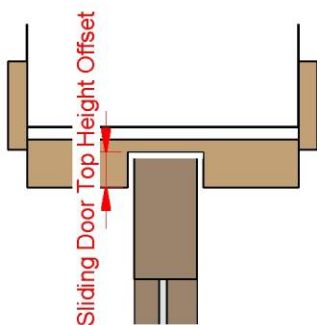
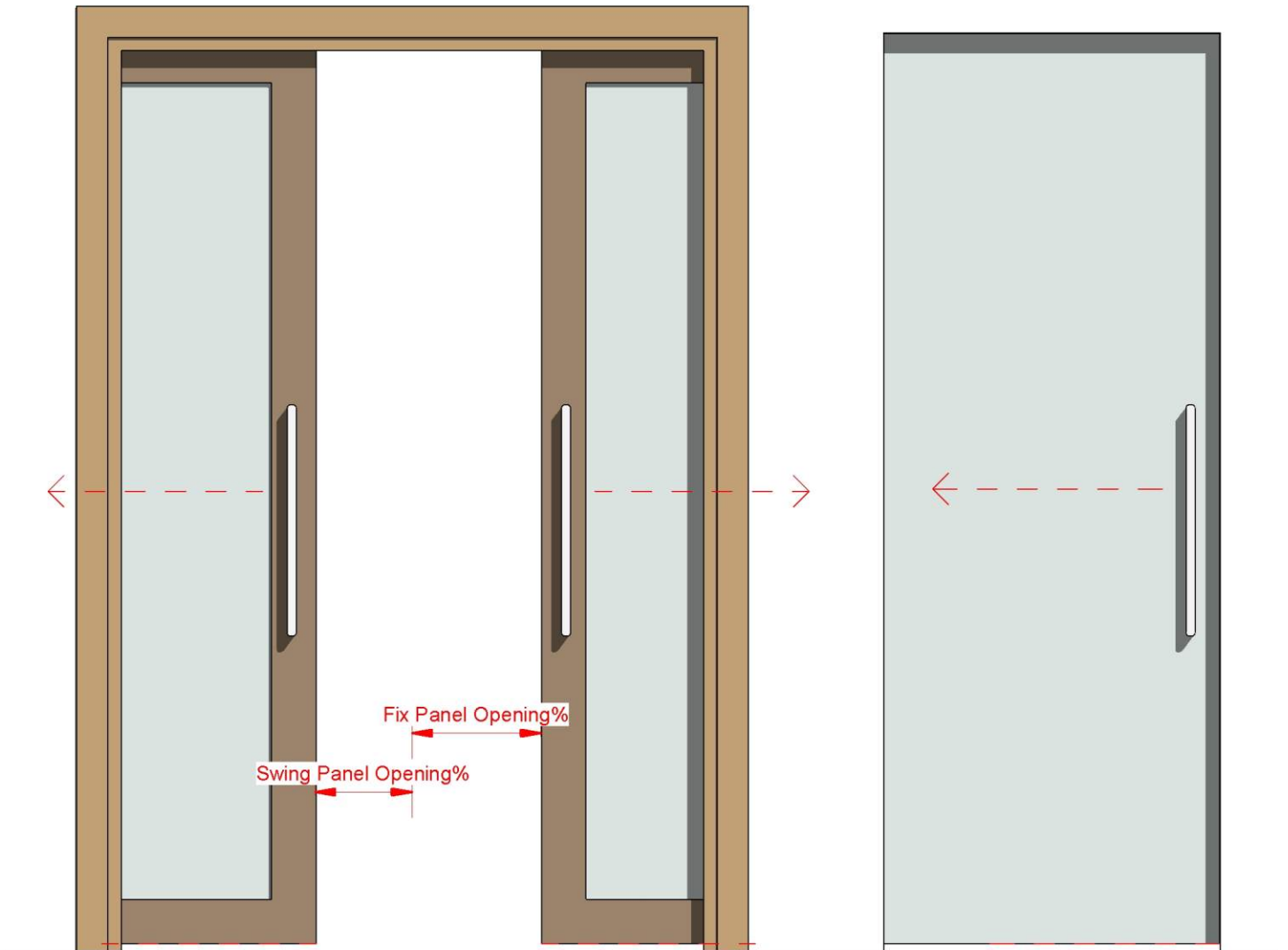
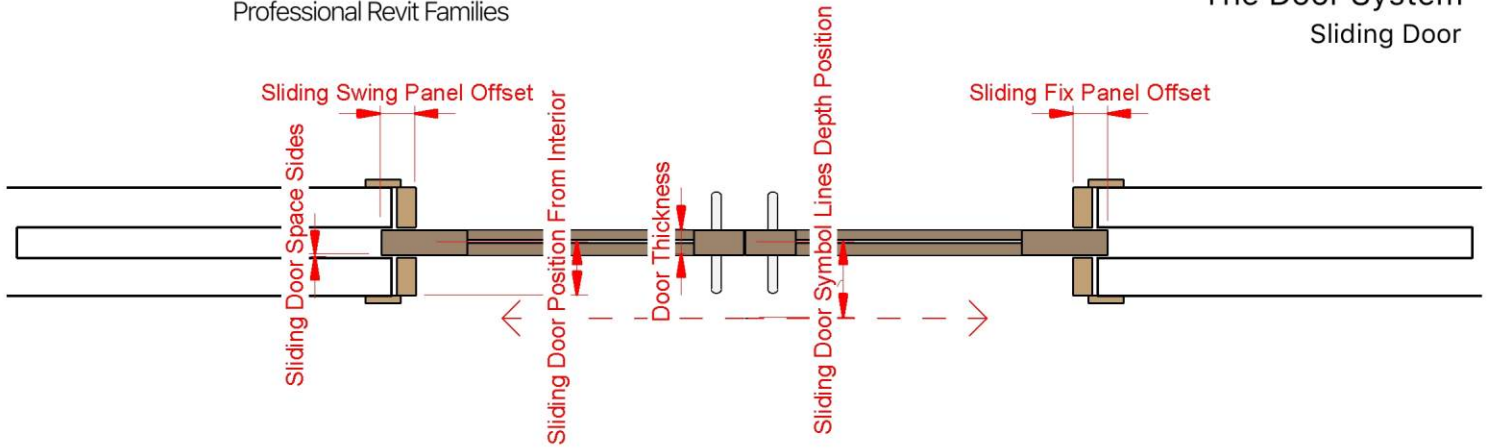

- Sliding Door
- Frame Visibility

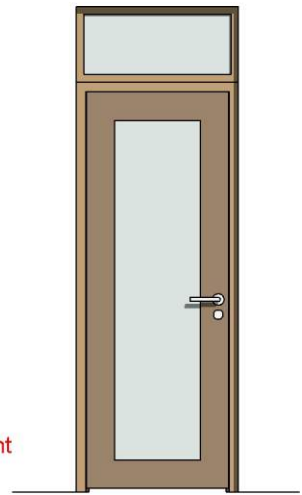
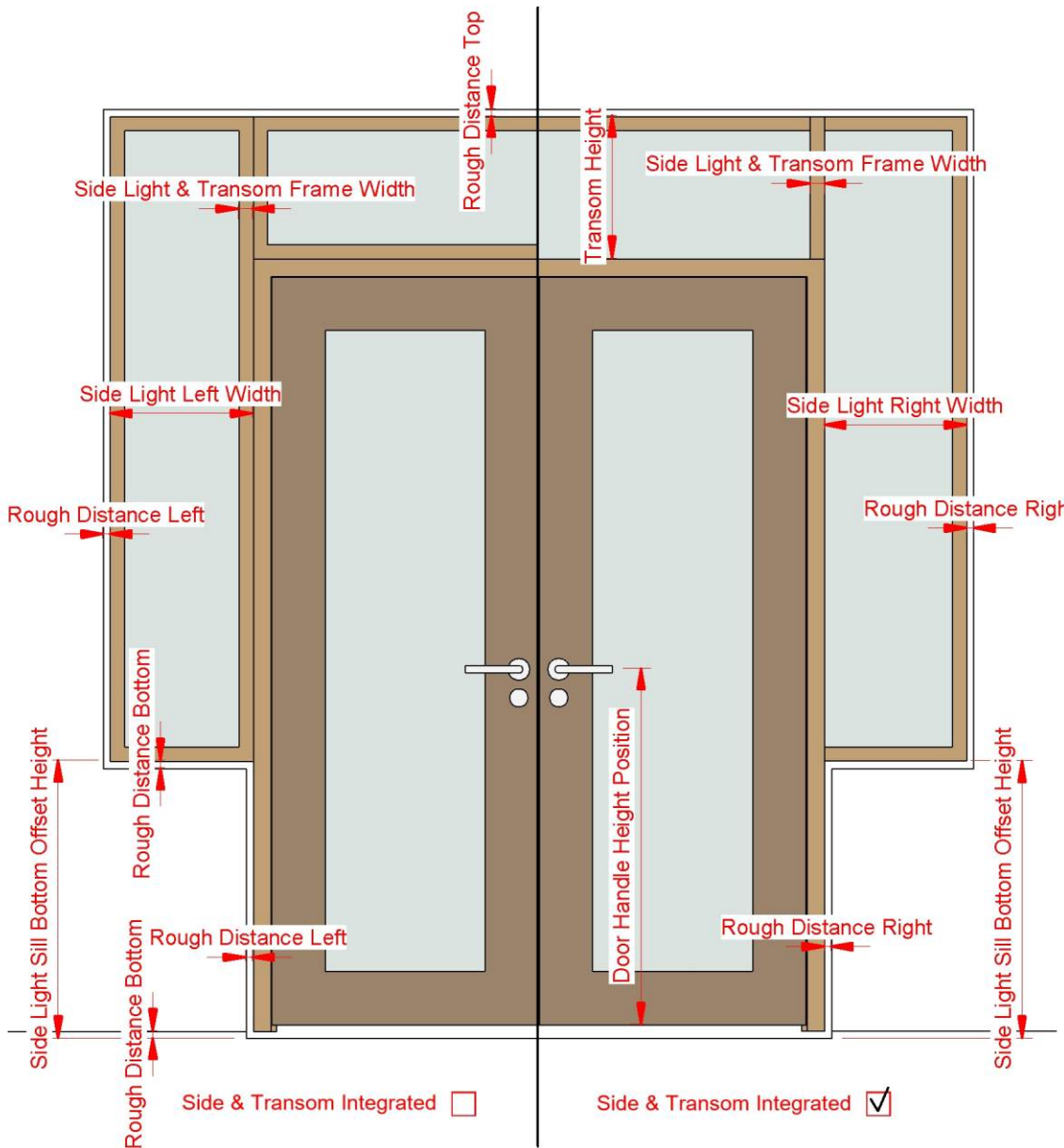

Transom Window Visibility

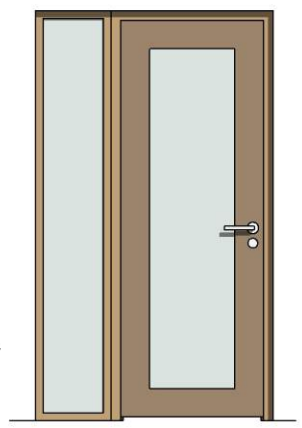

Side Light Left Visibility

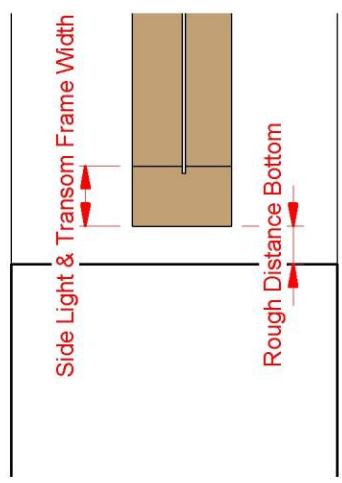

Side Light Sill Visibility

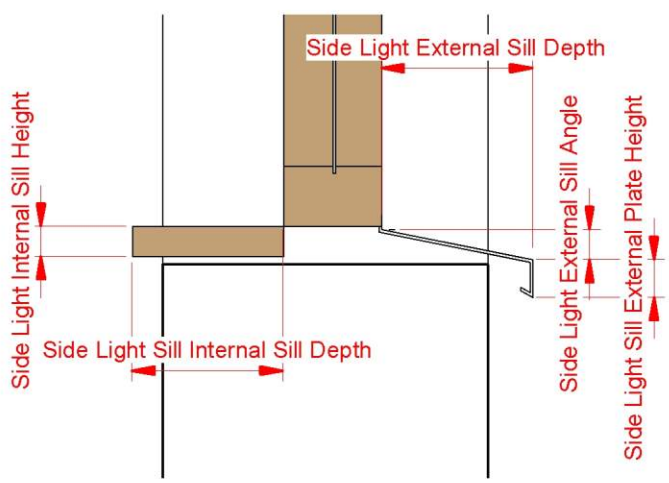

Side Light Sill Visibility

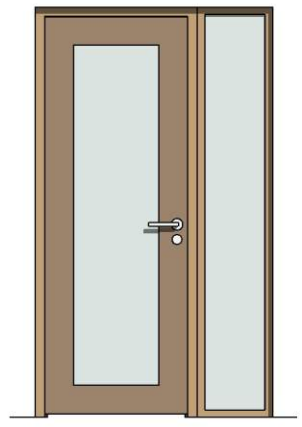

Side Light Right Visibility

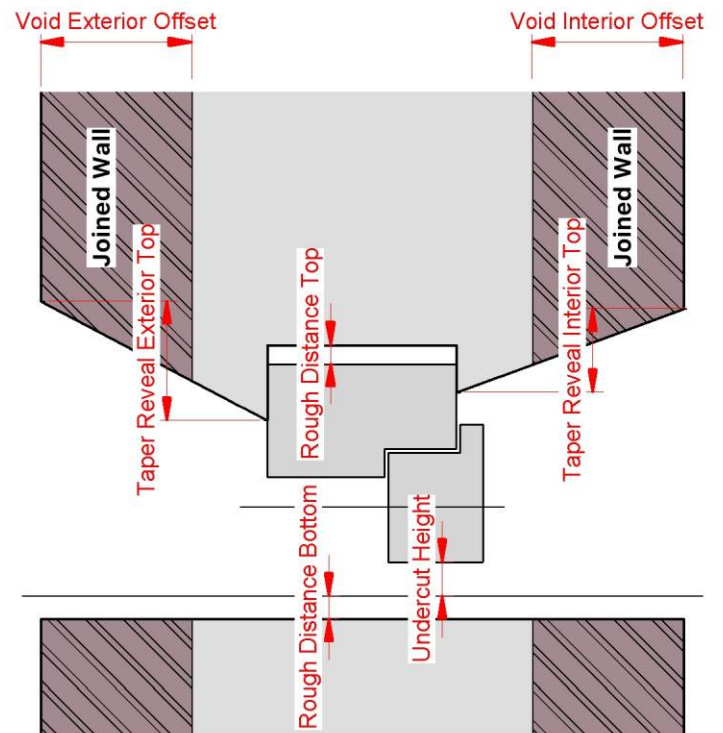
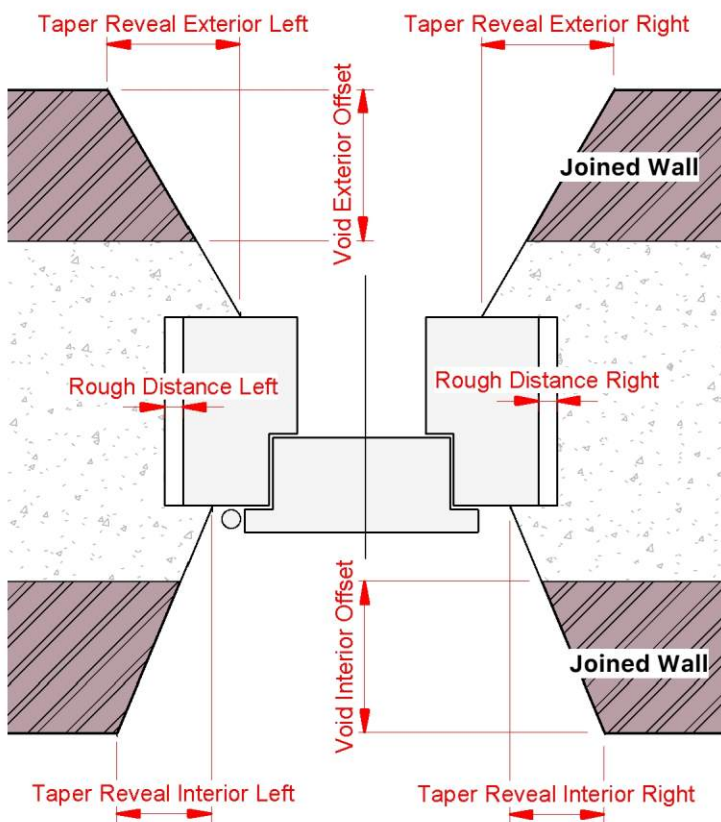
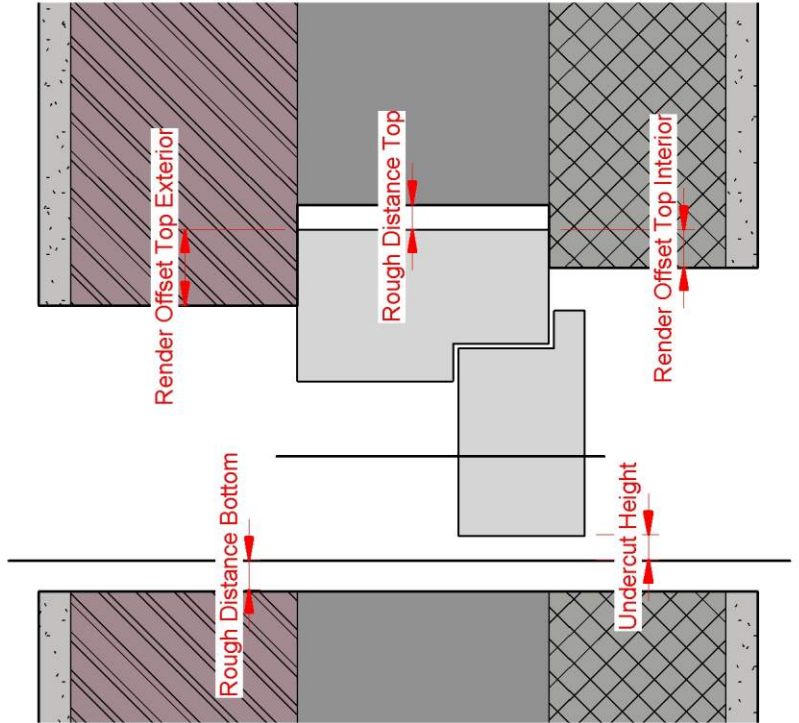
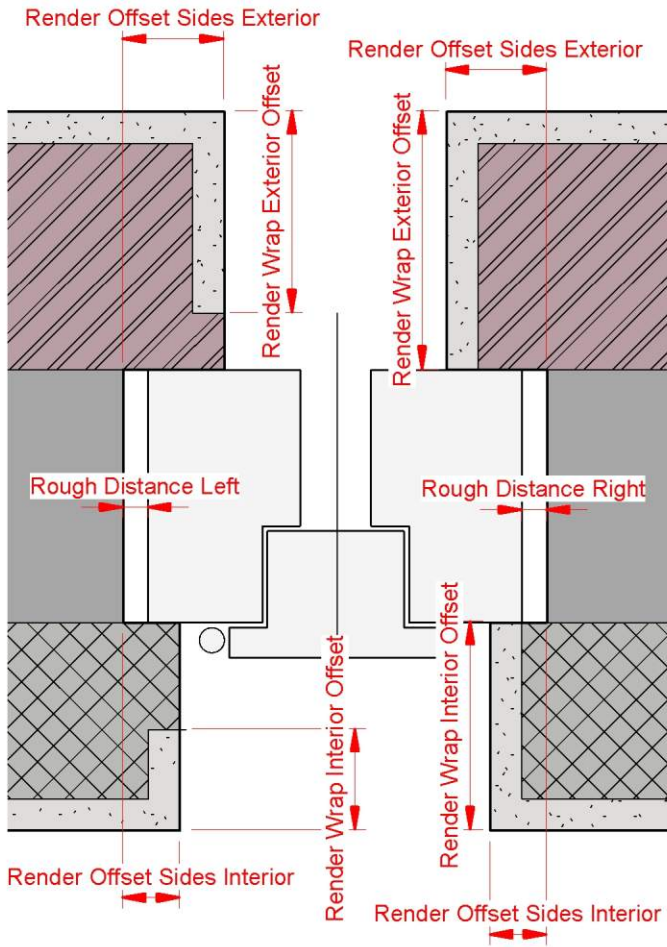

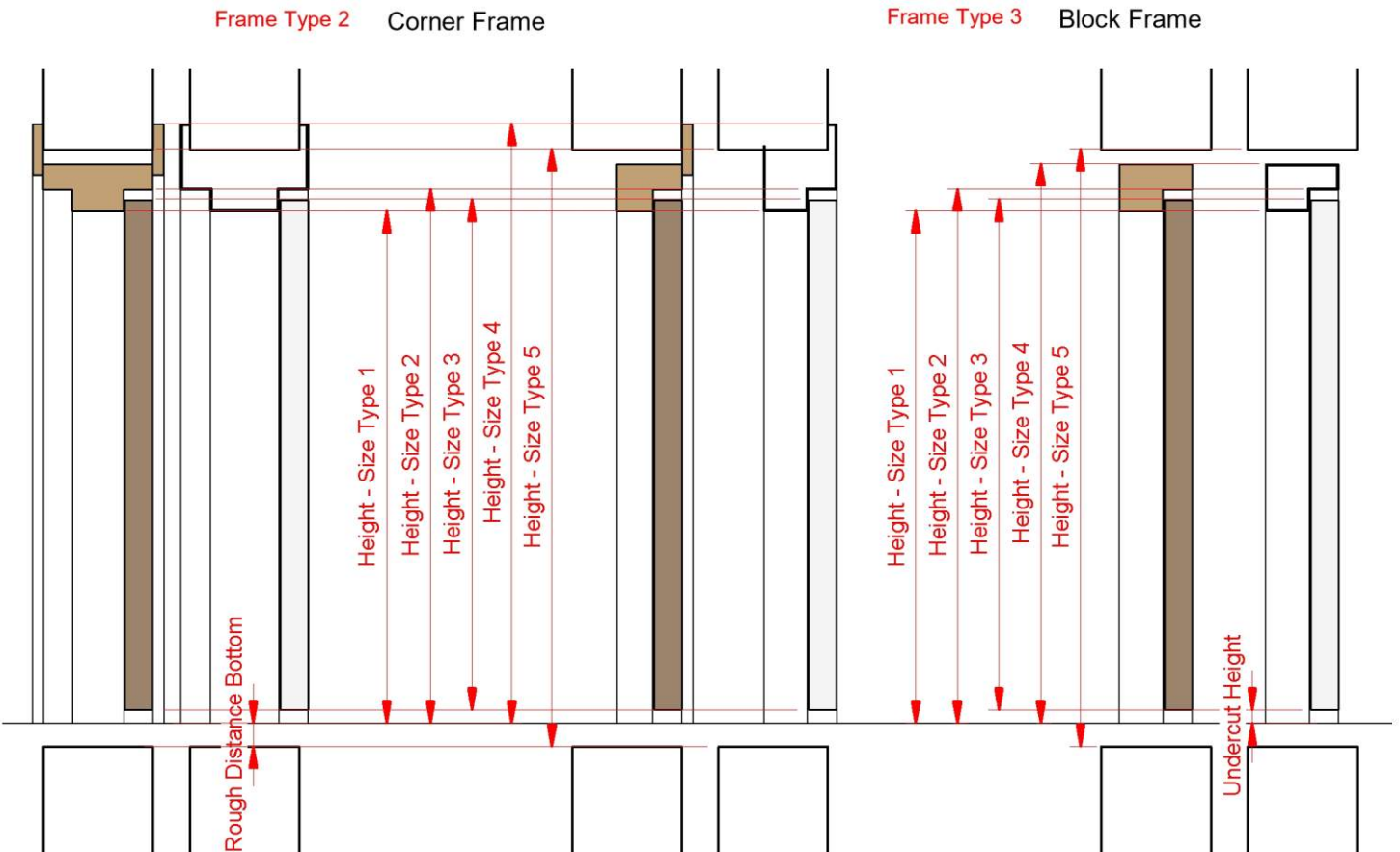
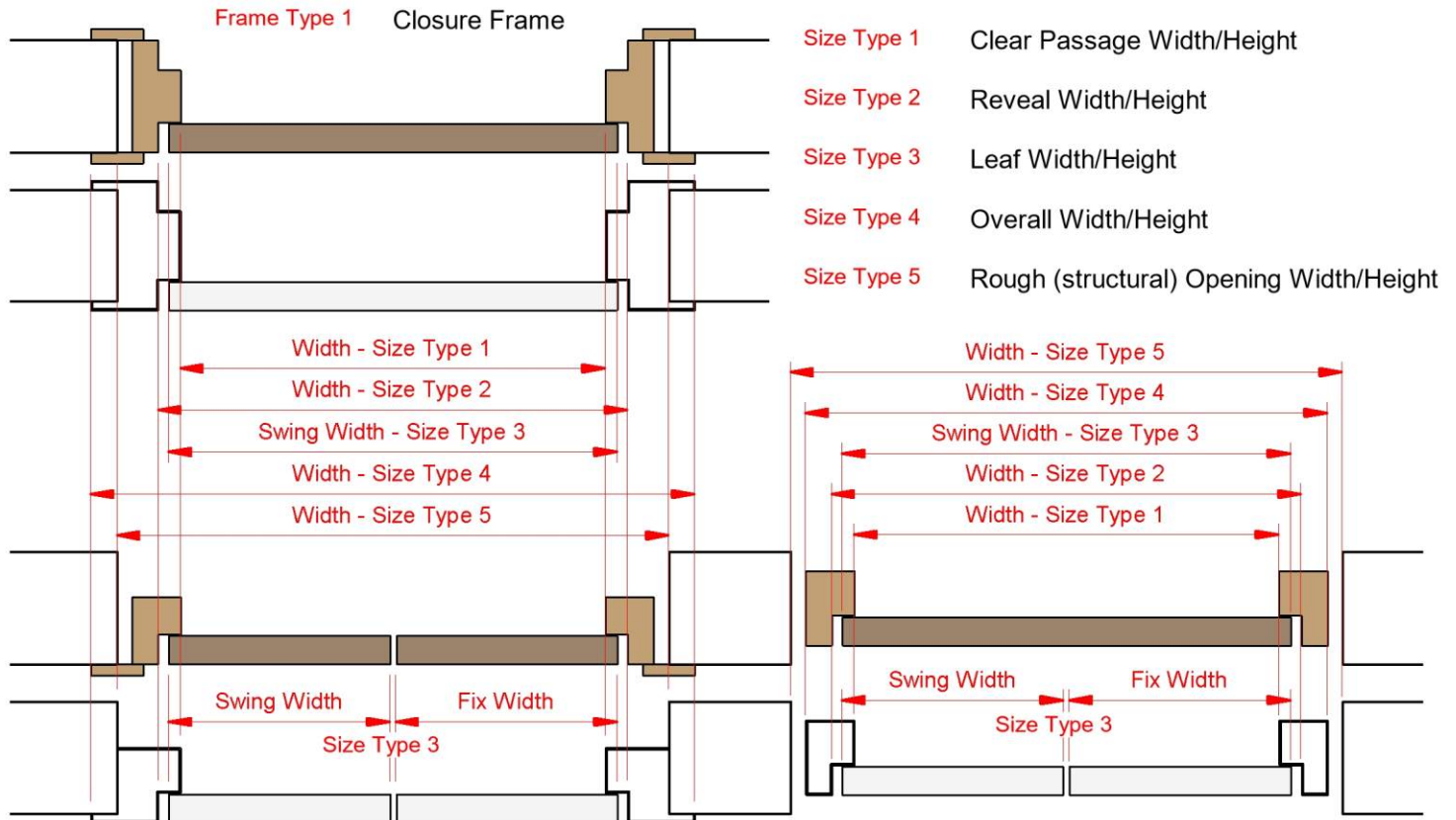

Frame Type 1 Closure Frame

Frame Type 2 Corner Frame

Frame Type 3 Block Frame

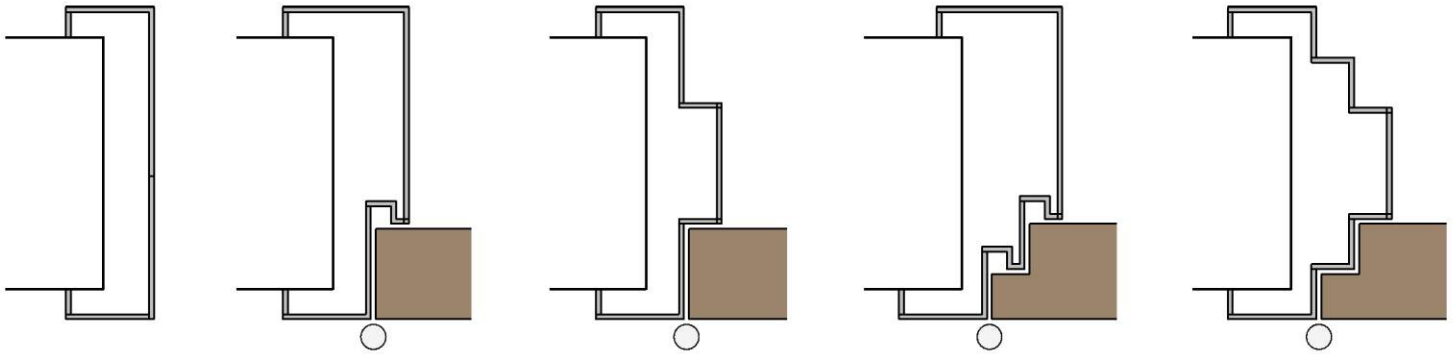

Frame Rebate 0

Frame Rebate 1

Frame Rebate 1

Frame Rebate 2

Frame Rebate 2

Groove Visibility

Double Rebate

Groove Visibility

Double Rebate

Groove Visibility

Groove Visibility

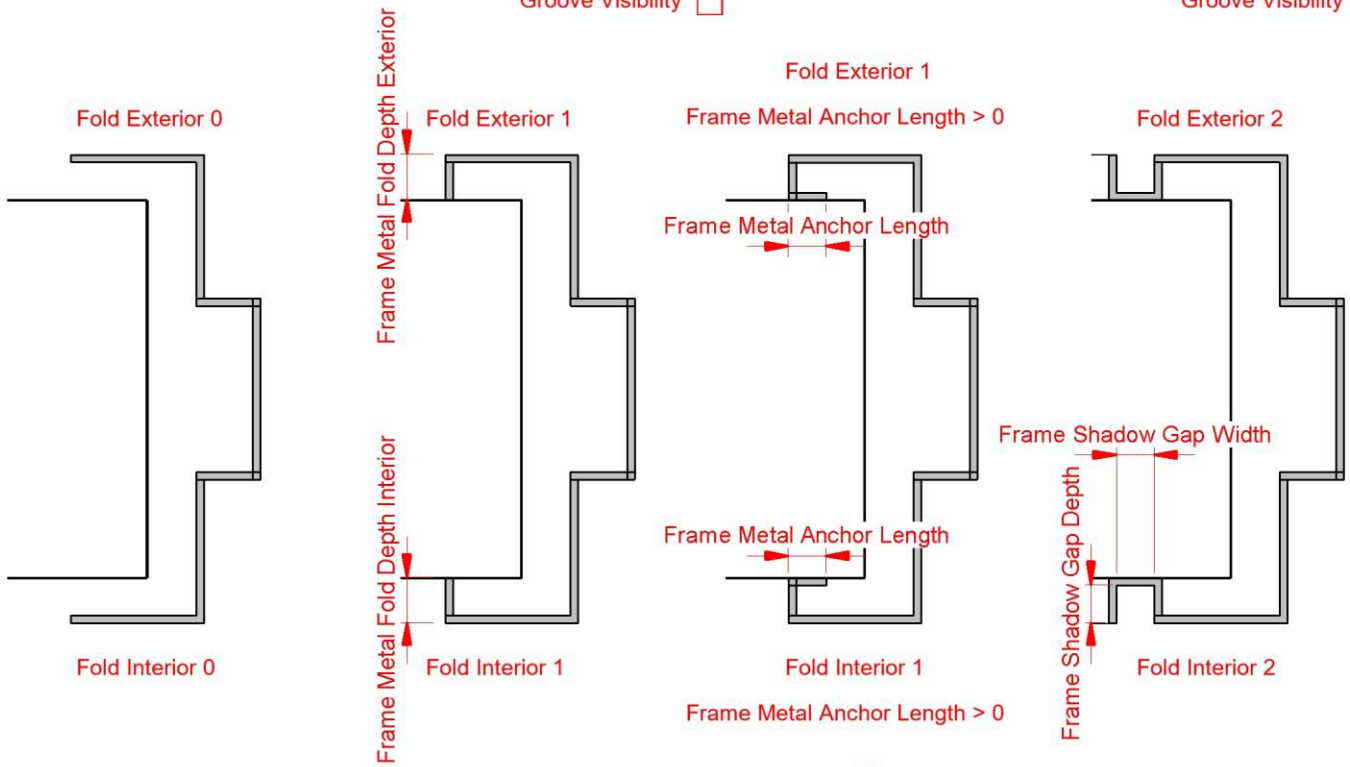

Fold Exterior 0

Fold Exterior 1

Fold Exterior 1

Fold Exterior 2

Fold Interior 0

Fold Interior 1

Fold Interior 1

Fold Interior 2

Fold Exterior 0

Fold Exterior 0

Fold Exterior 1

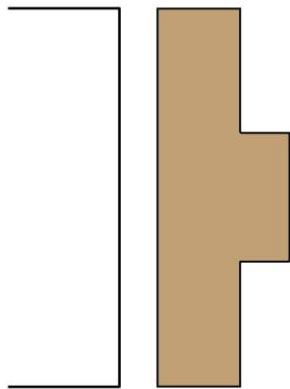

Fold Interior 0

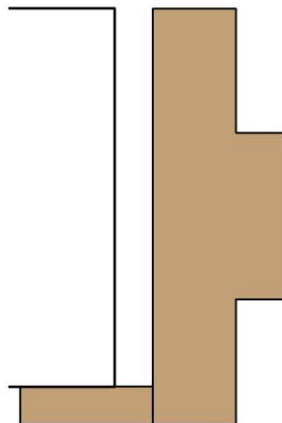

Fold Interior 1

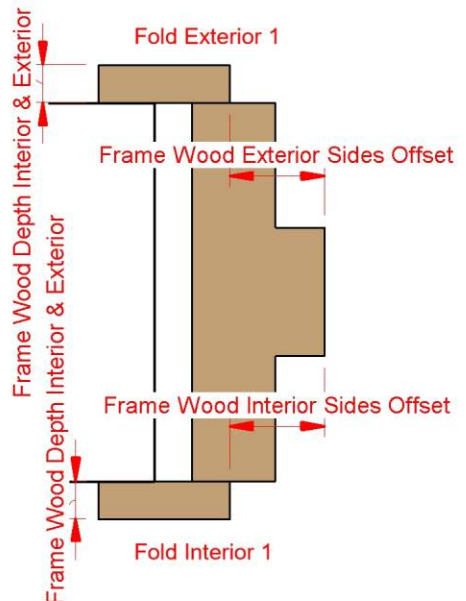

Fold Interior 1

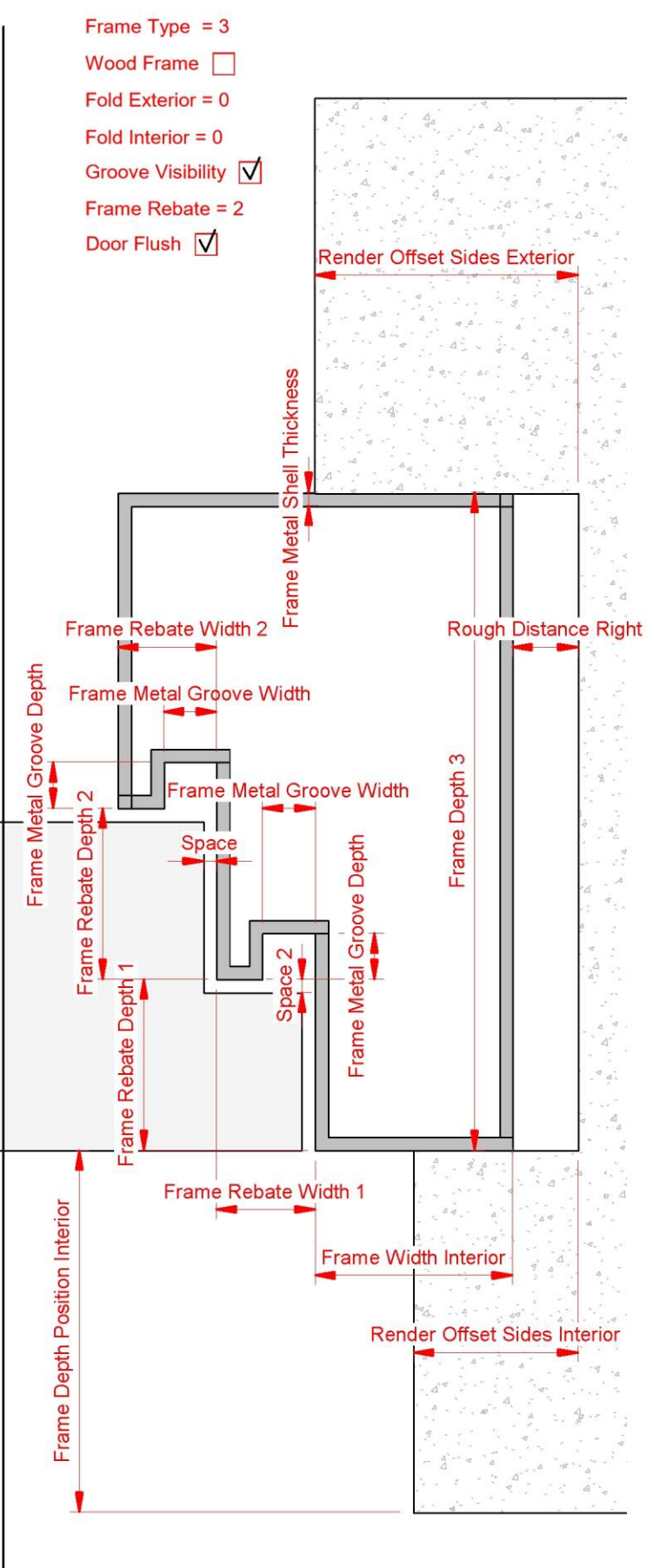
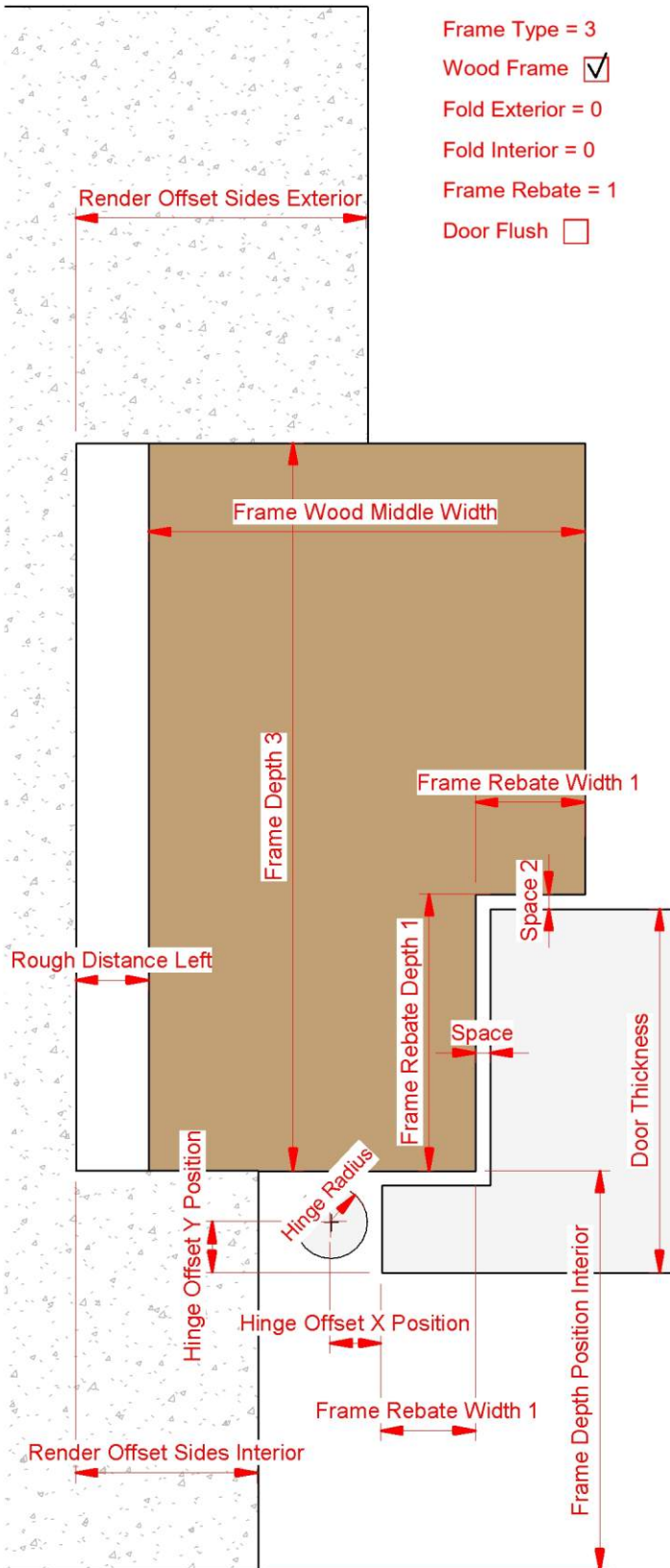

- Frame Type = 1
- Wood Frame
- Fold Exterior = 1
- Fold Interior = 1
- Frame Rebate = 2
- Double Rebate
- Door Flush

- Frame Type = 1
- Wood Frame
- Fold Exterior = 2
- Fold Interior = 1
- Groove Visibility
- Frame Rebate = 2
- Double Rebate
- Door Flush

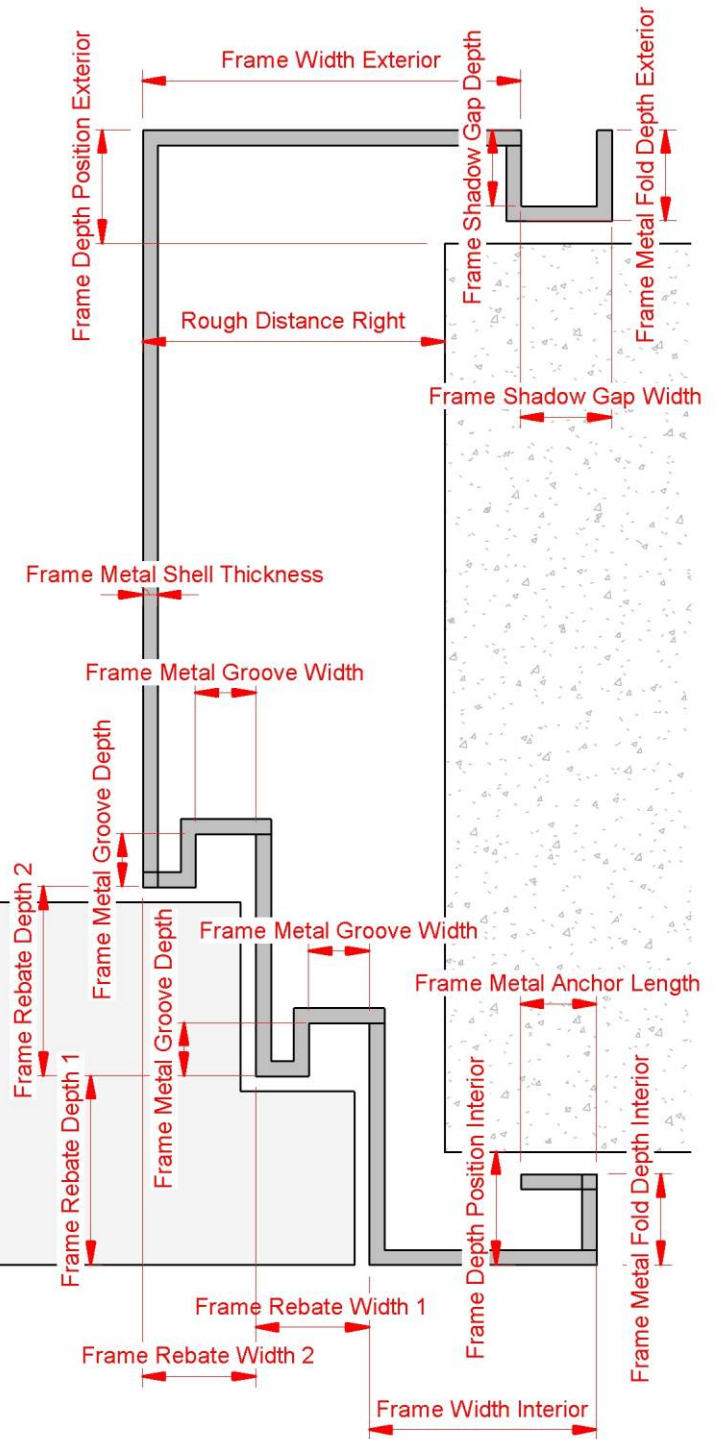
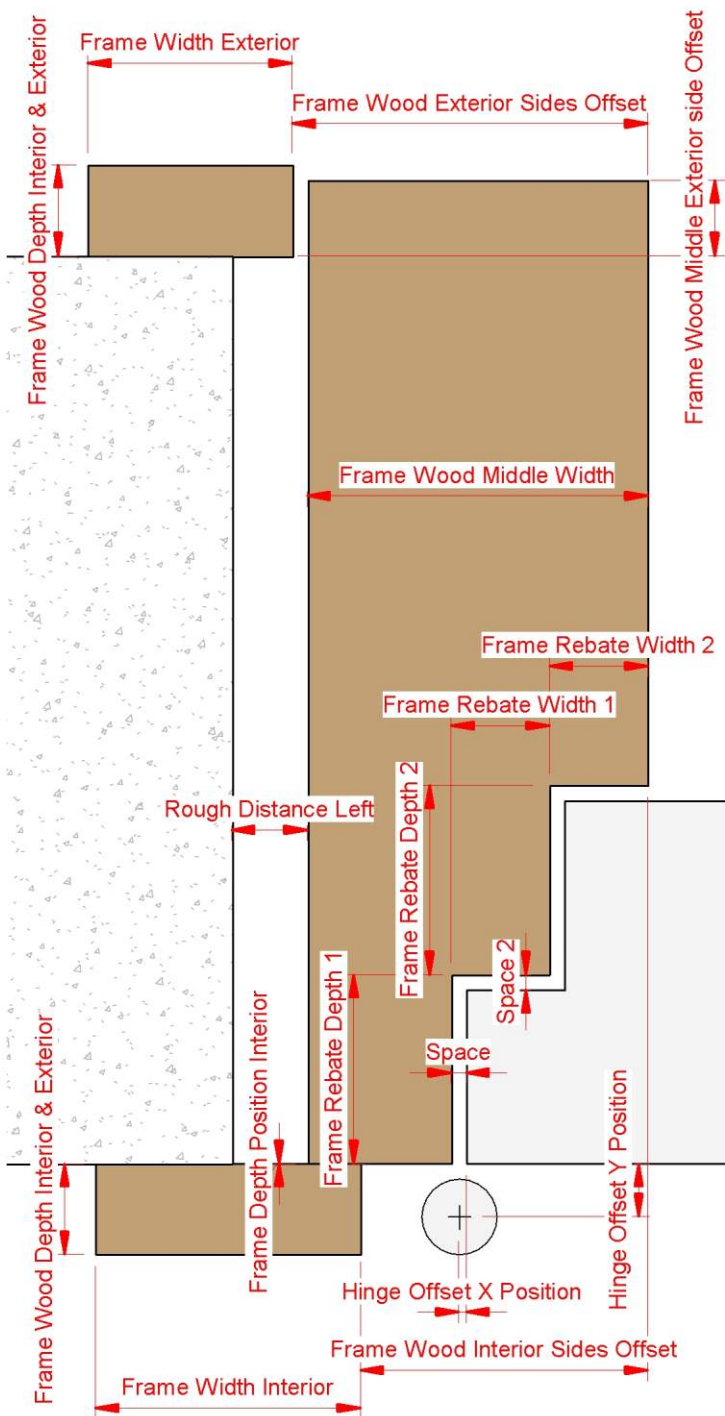

- Frame Type = 1
- Wood Frame
- Fold Exterior = 1
- Fold Interior = 1
- Door Stop Visibility
- Frame Rebate = 0
- Double Rebate
- Door Flush

- Frame Type = 1
- Wood Frame
- Fold Exterior = 2
- Fold Interior = 1
- Groove Visibility
- Frame Rebate = 2
- Double Rebate
- Door Flush

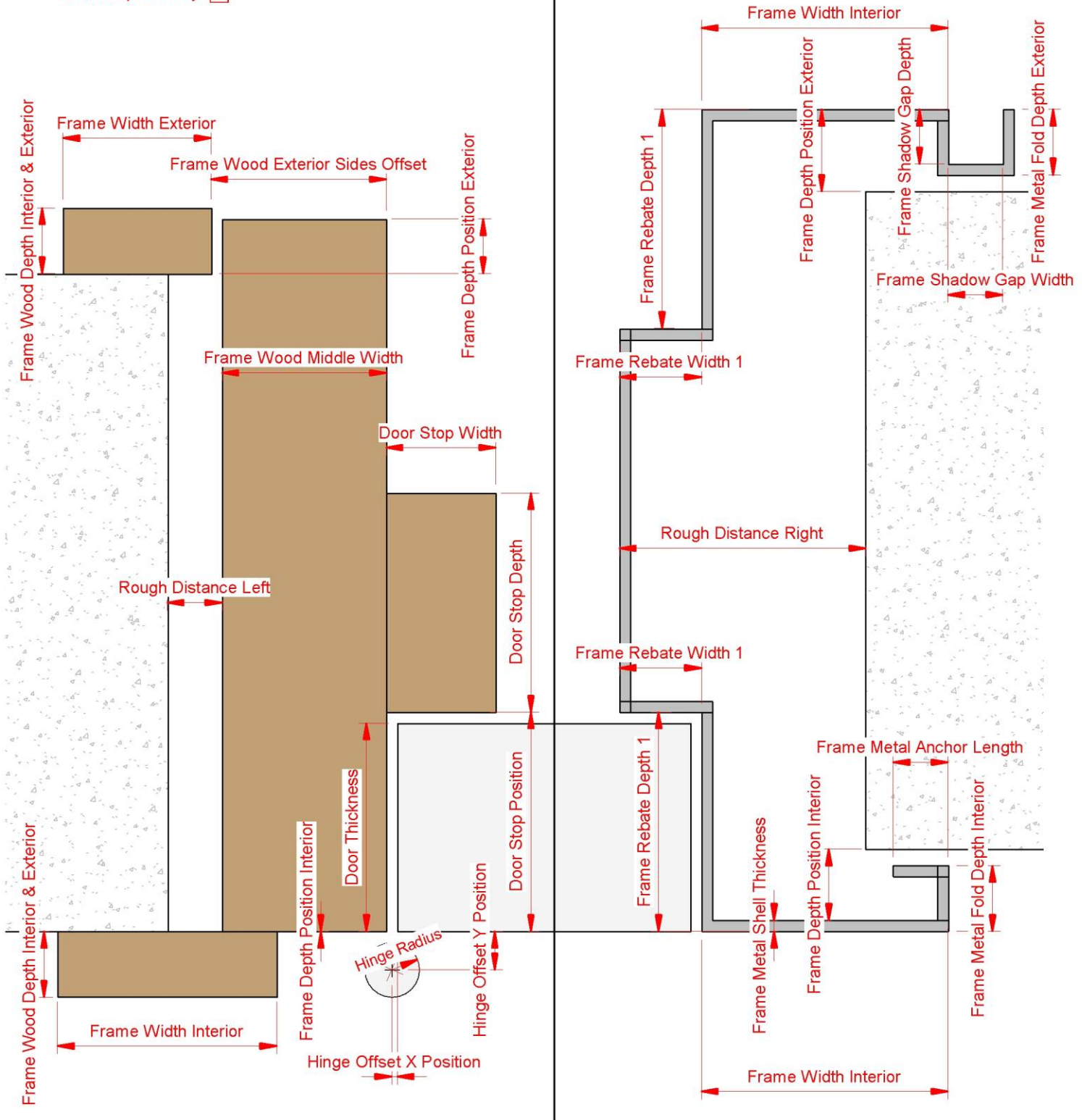

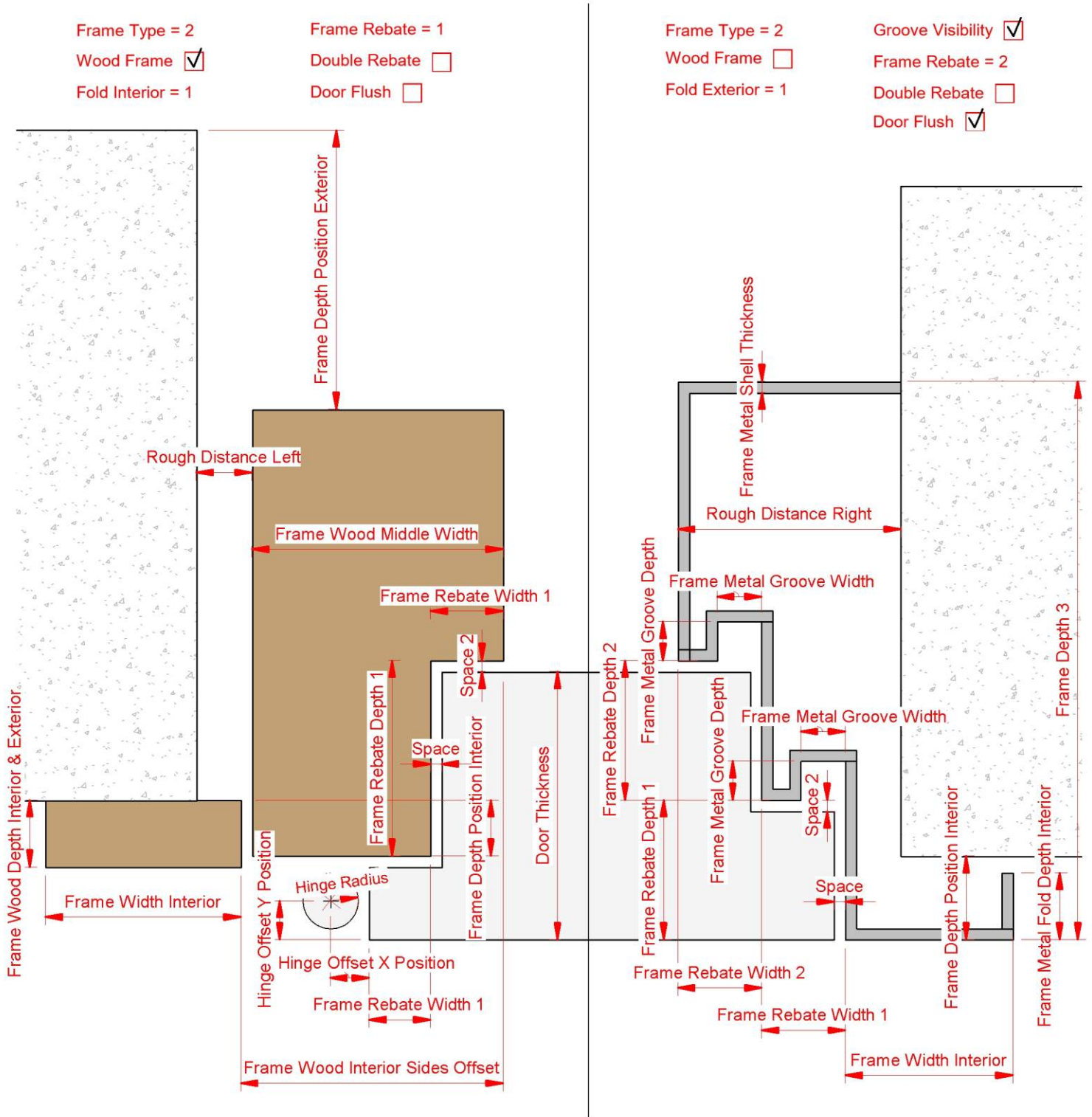

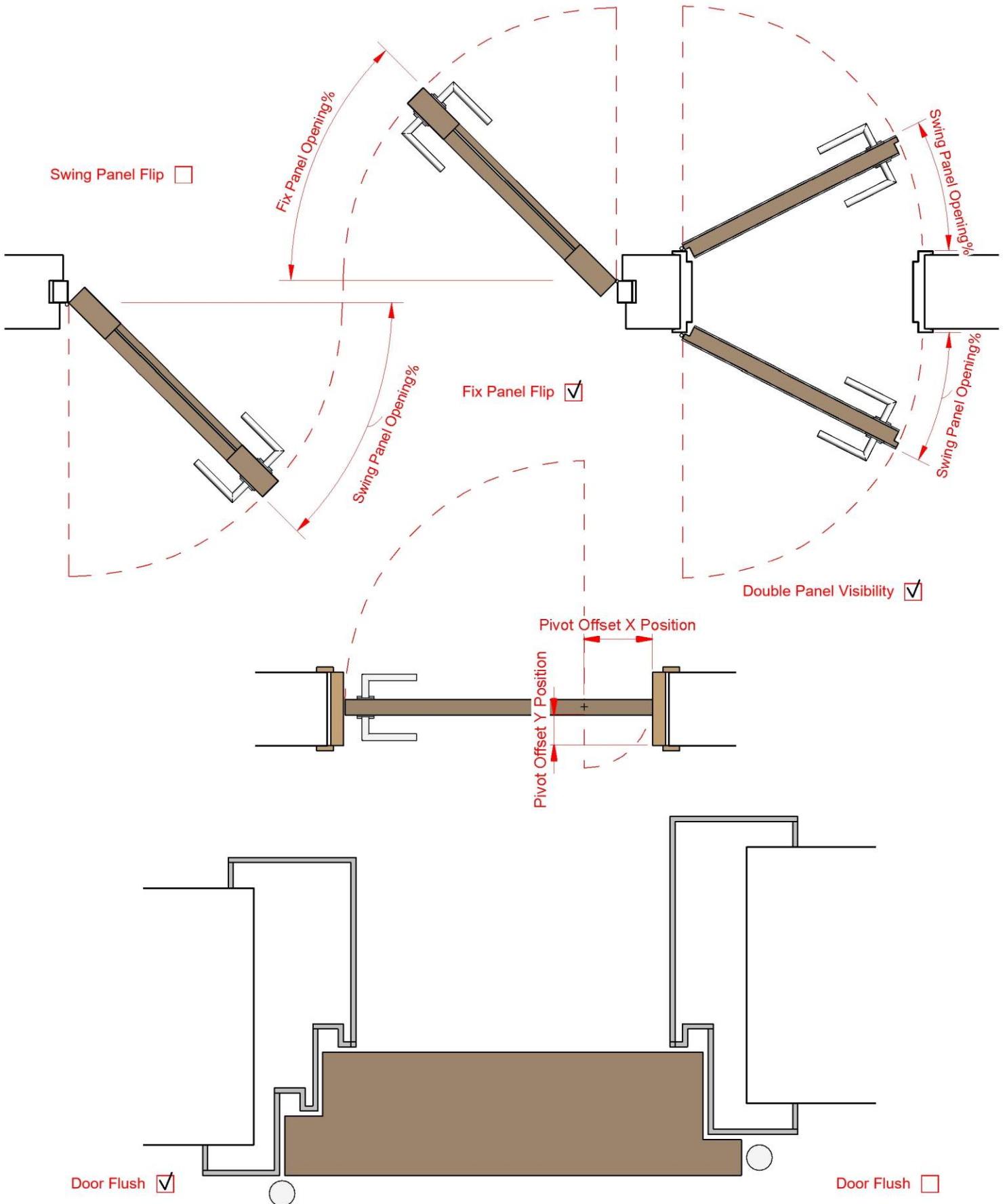

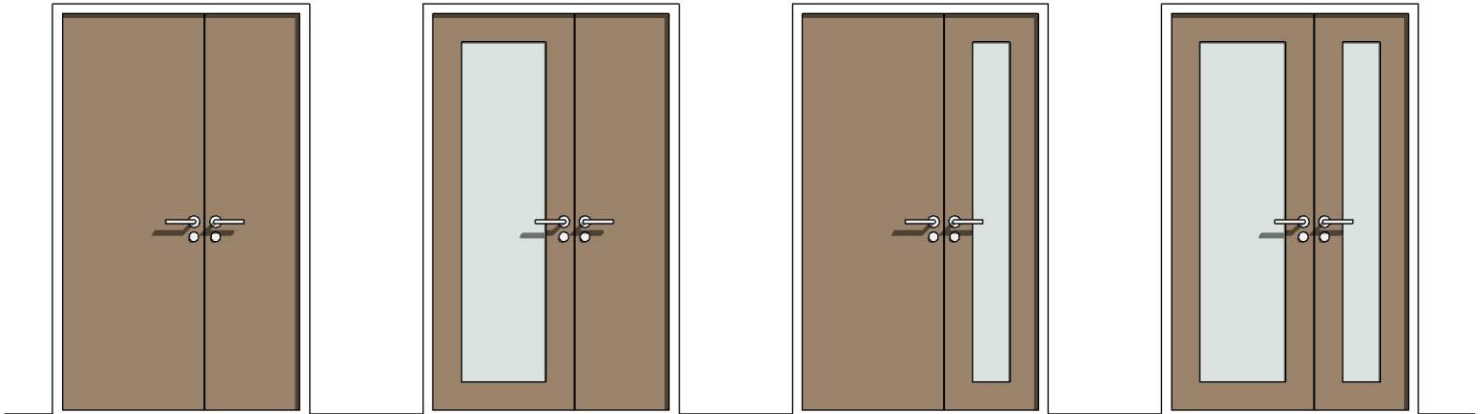

- | | | | |
|---|--|--|--|
| Swing Panel Glazing Visibility <input type="checkbox"/> | Swing Panel Glazing Visibility <input checked="" type="checkbox"/> | Swing Panel Glazing Visibility <input type="checkbox"/> | Swing Panel Glazing Visibility <input checked="" type="checkbox"/> |
| Fix Panel Glazing Visibility <input type="checkbox"/> | Fix Panel Glazing Visibility <input type="checkbox"/> | Fix Panel Glazing Visibility <input checked="" type="checkbox"/> | Fix Panel Glazing Visibility <input checked="" type="checkbox"/> |

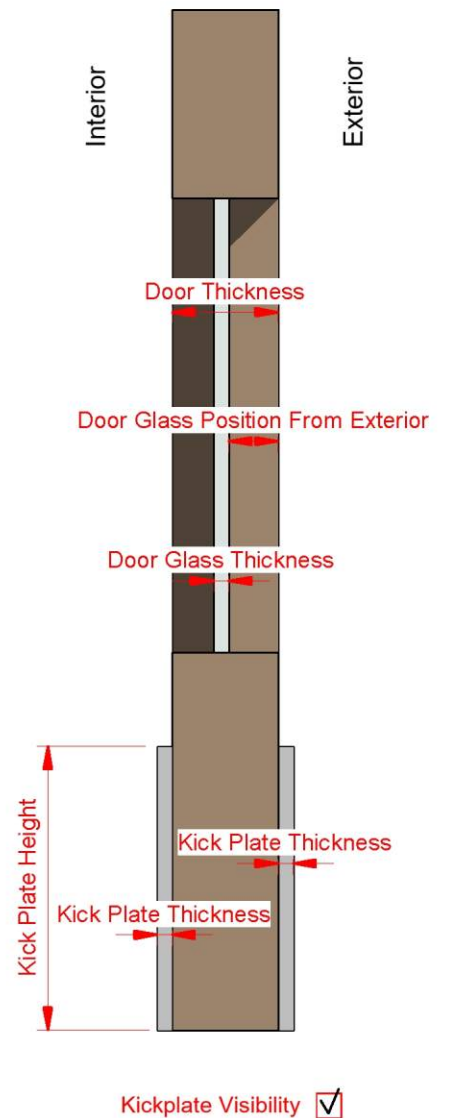
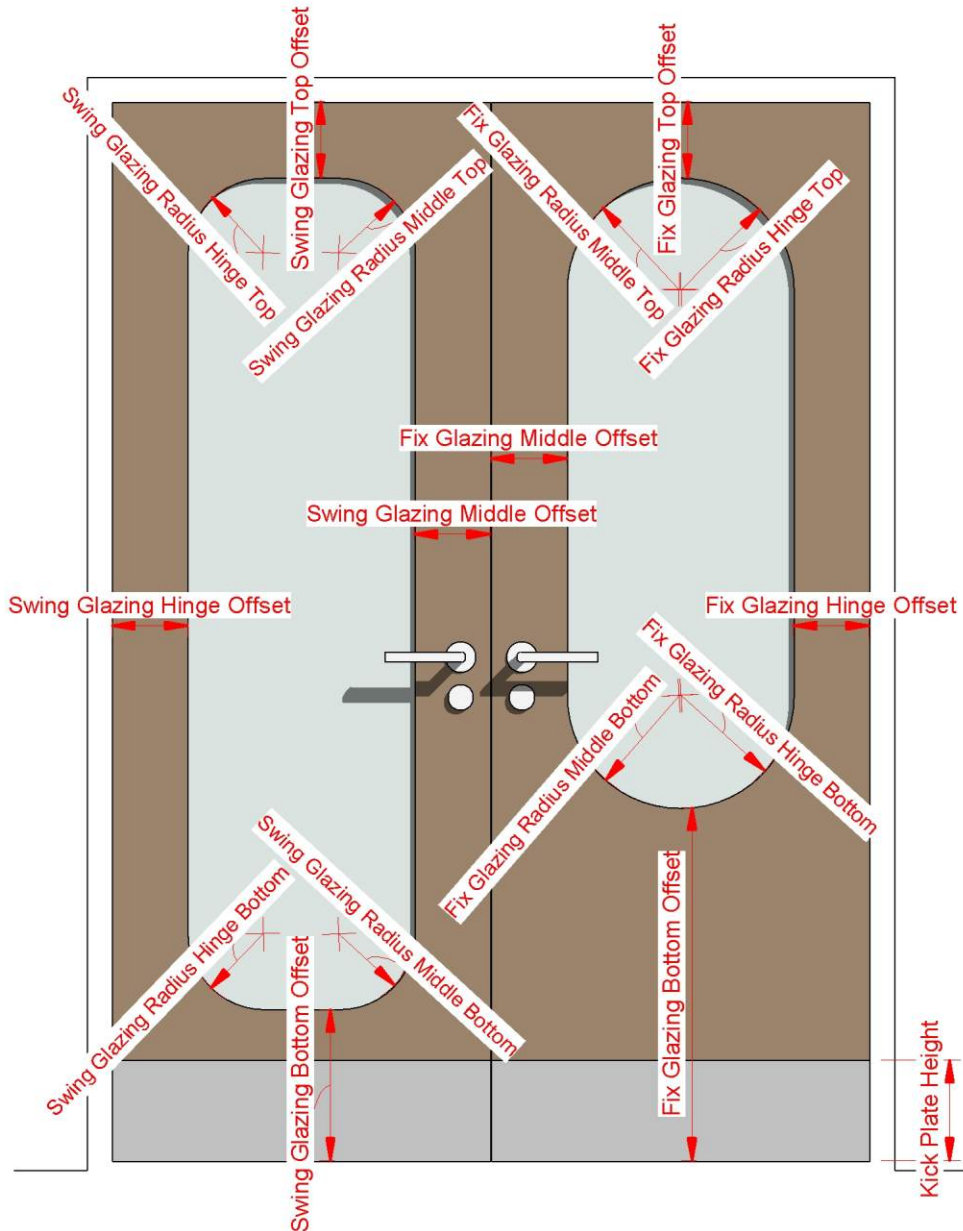

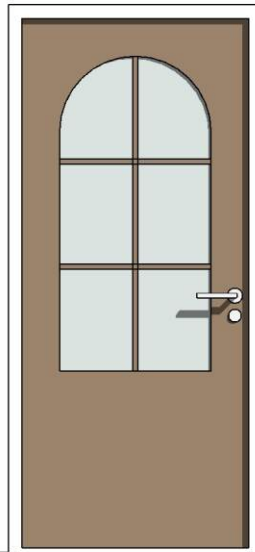
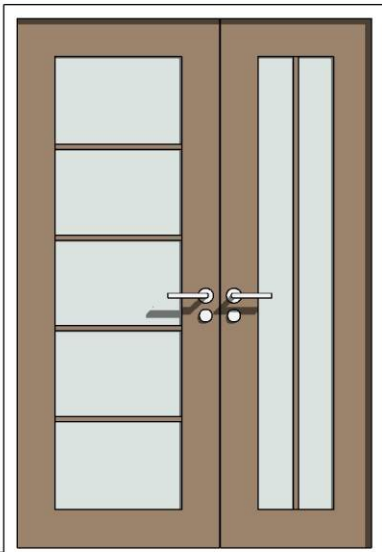

Swing Panel Horizontal Glazing Bar Count = 4 Swing Panel Horizontal Glazing Bar Count = 2
 Swing Panel Vertical Glazing Bar Count = 0 Swing Panel Vertical Glazing Bar Count = 1
 Fix Panel Horizontal Glazing Bar Count = 0
 Fix Panel Vertical Glazing Bar Count = 1

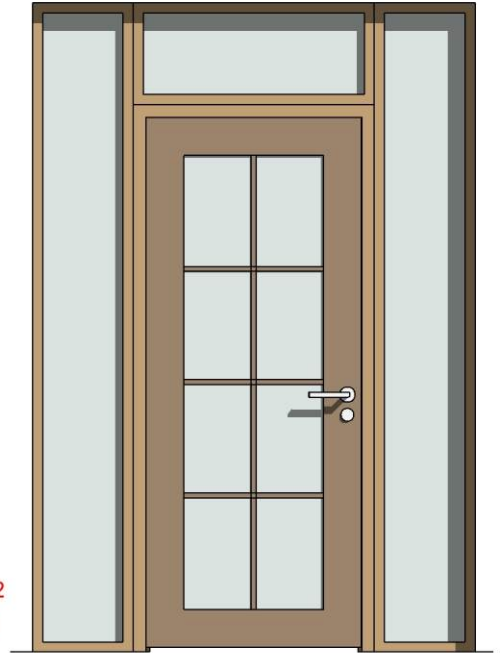

Swing Panel Horizontal Glazing Bar Count = 3
 Swing Panel Vertical Glazing Bar Count = 1

Note: Side Light & Transom Window doesn't support glazing bars

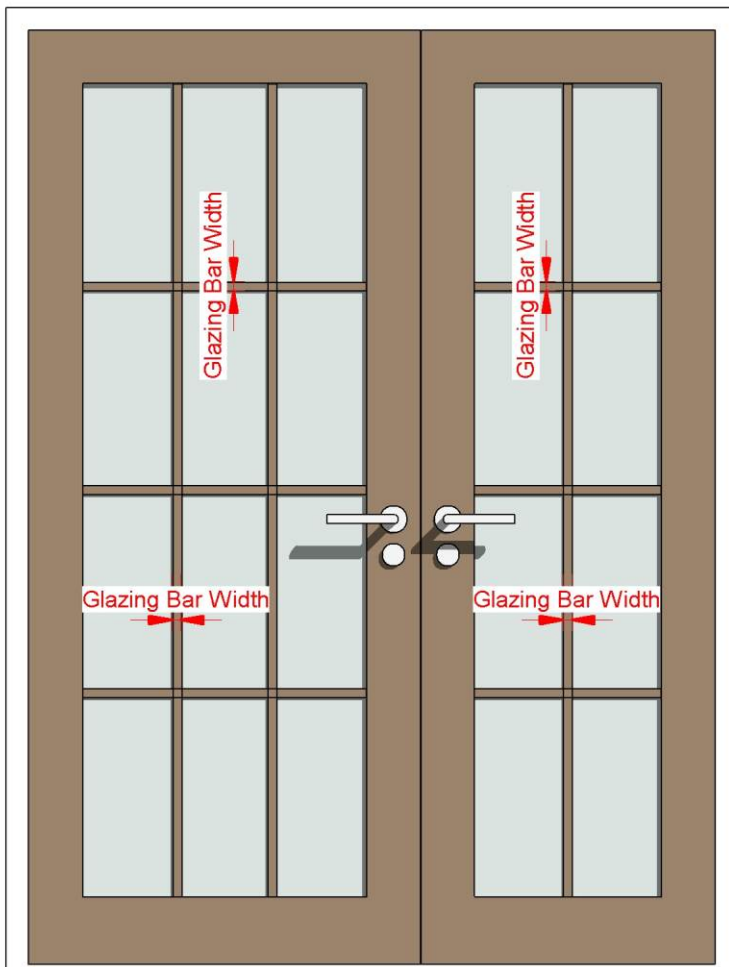

Swing Panel Horizontal Glazing Bar Count = 3 Fix Panel Horizontal Glazing Bar Count = 3
 Swing Panel Vertical Glazing Bar Count = 2 Fix Panel Vertical Glazing Bar Count = 1

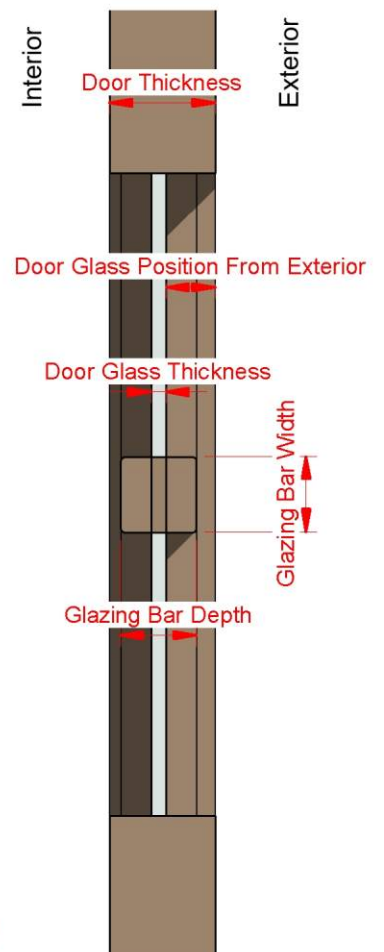

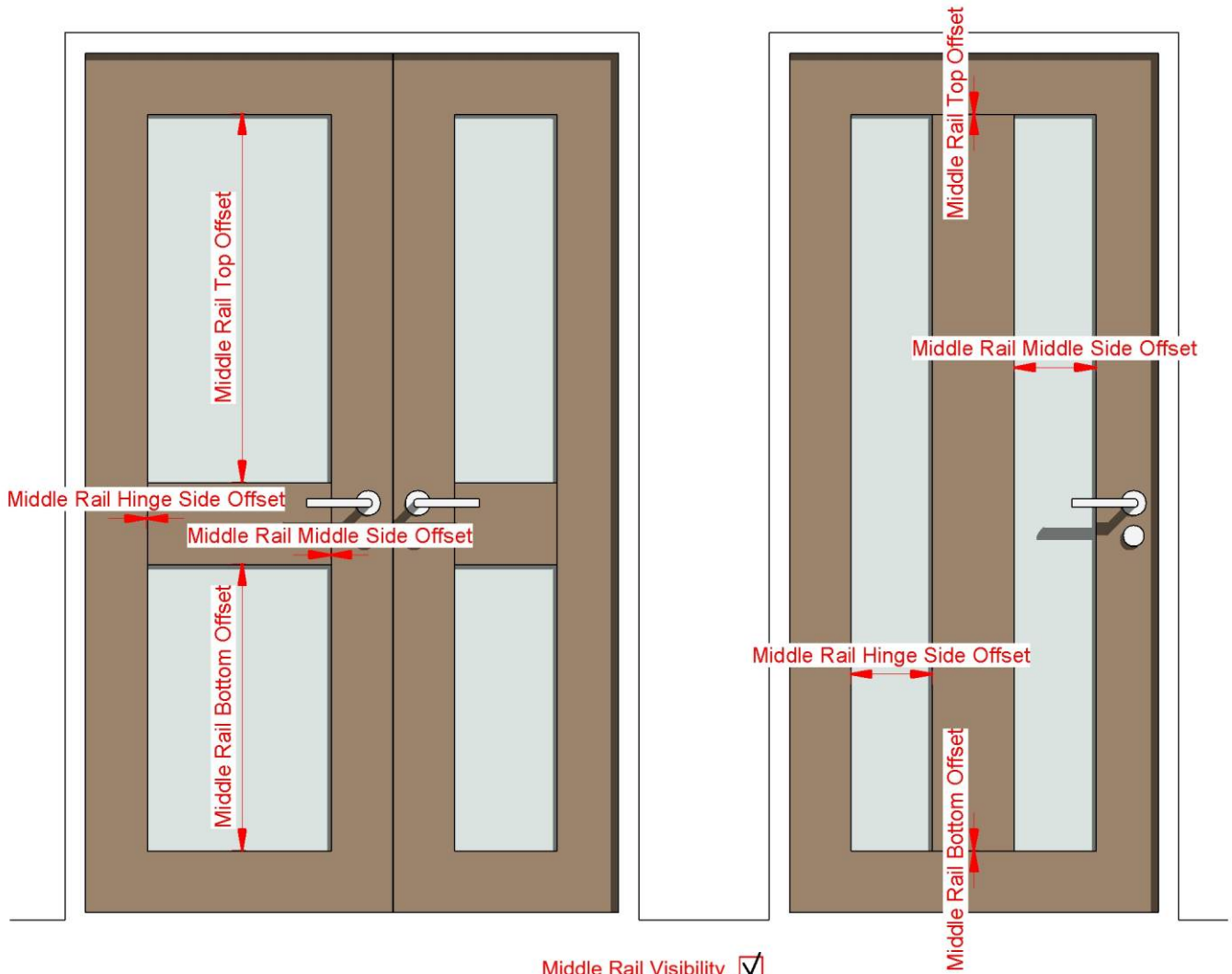

Middle Rail Visibility

Note: Related with Glazing Offsets and Radius

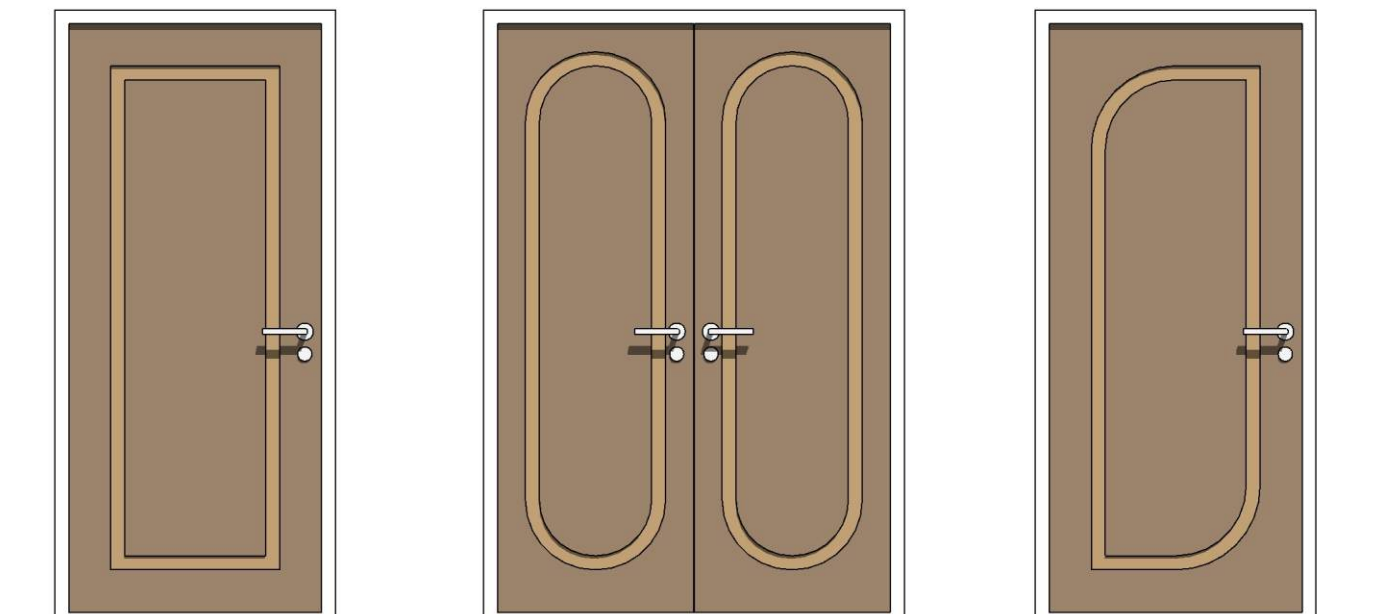

Swing Panel Glazing Visibility

Swing Panel Glazing Visibility

Swing Panel Glazing Visibility

Fix Panel Glazing Visibility

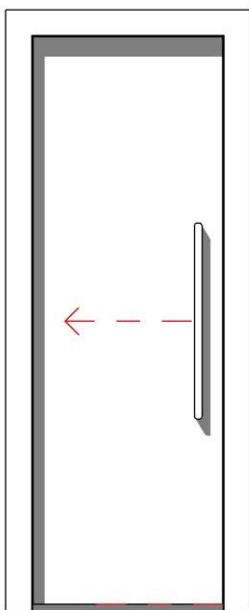
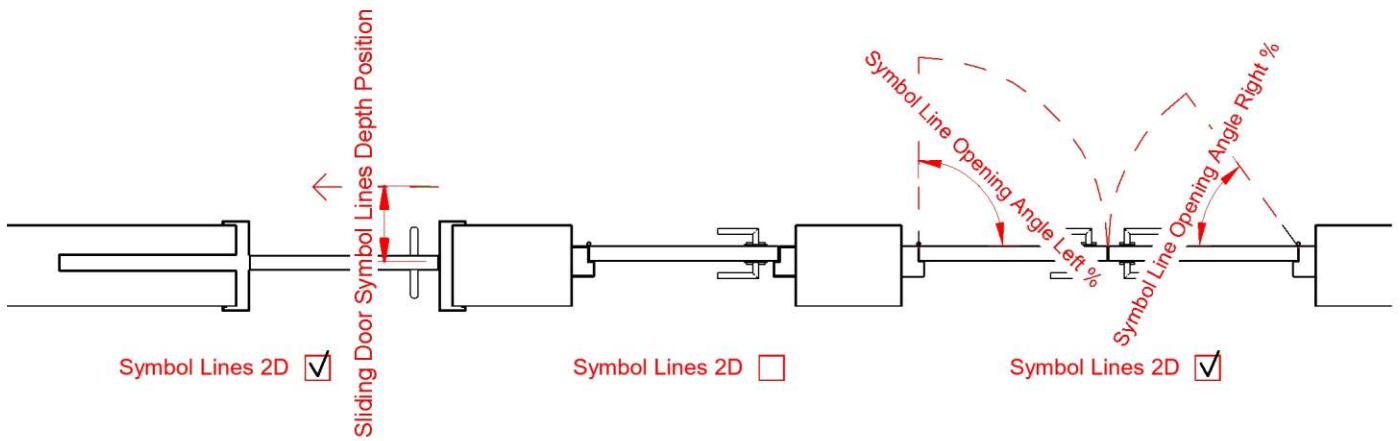

Symbol Lines 2D

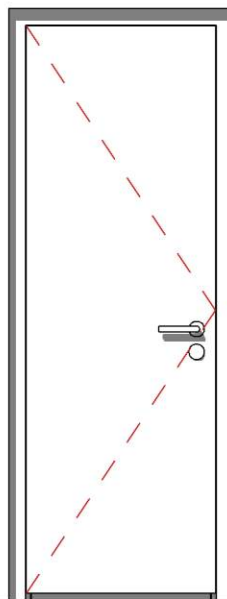

Symbol Lines Hinge Side

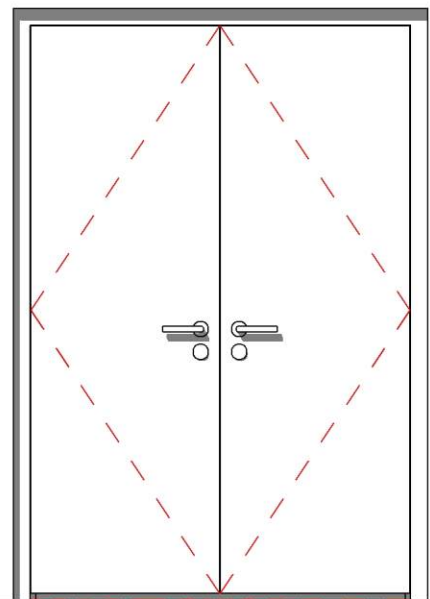

Symbol Lines Hinge Side

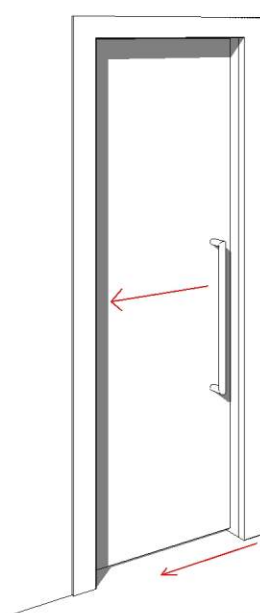

Symbol Lines 3D

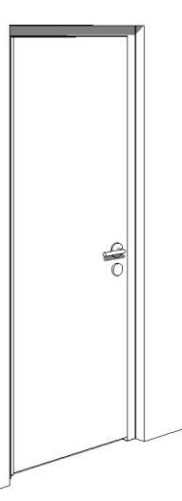

Symbol Lines 3D

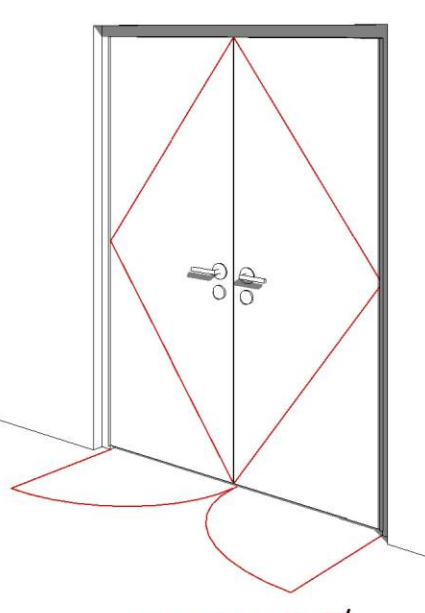

Symbol Lines 3D

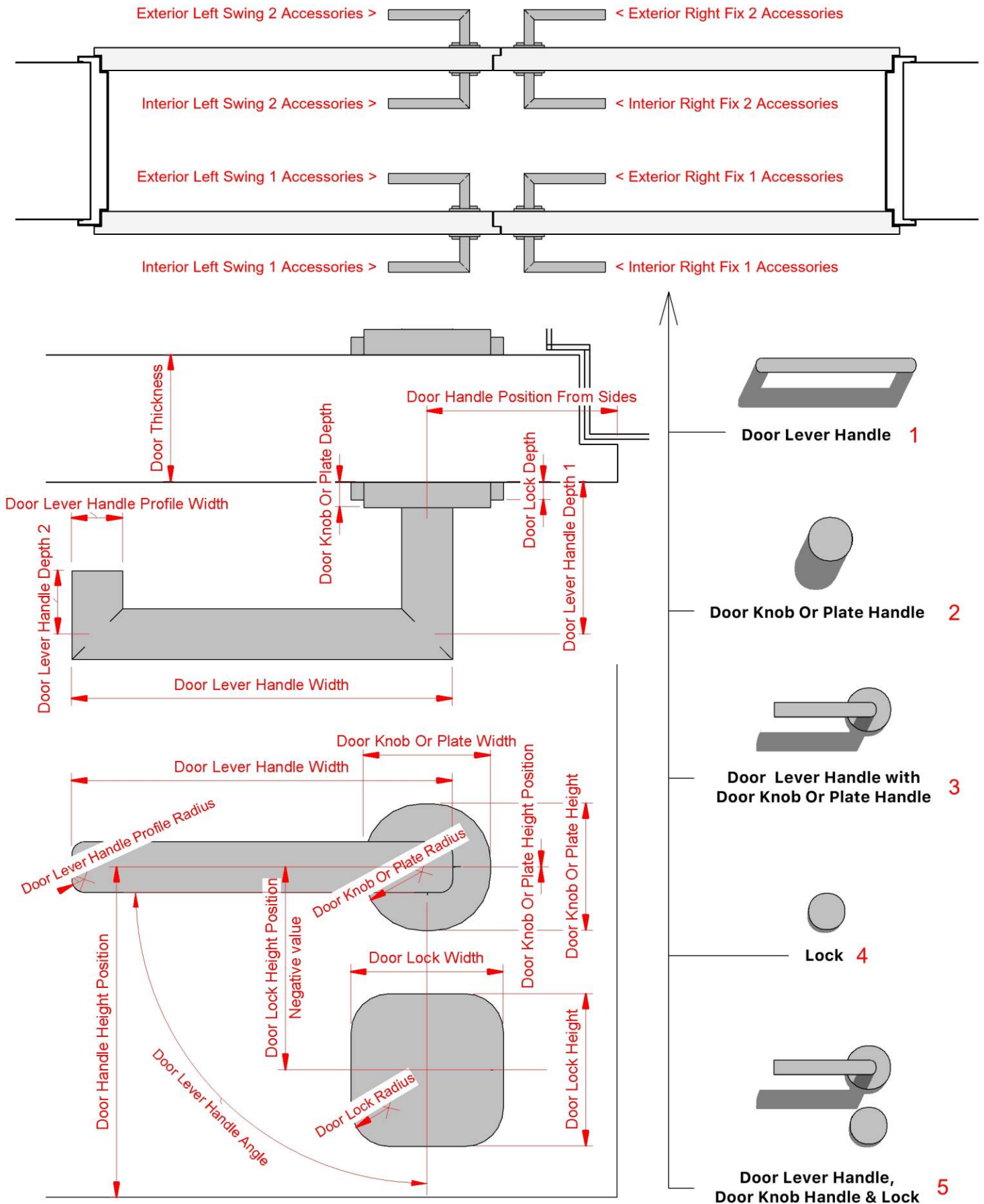

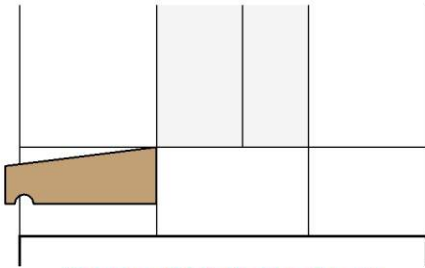

Threshold Visibility Exterior = 3

Threshold Visibility Interior = 0

Threshold Visibility Middle

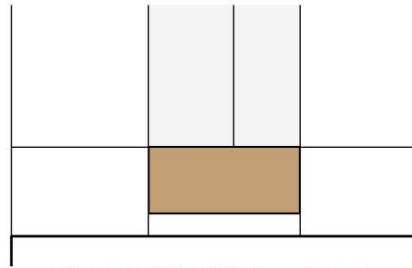

Threshold Visibility Exterior = 0

Threshold Visibility Interior = 0

Threshold Visibility Middle

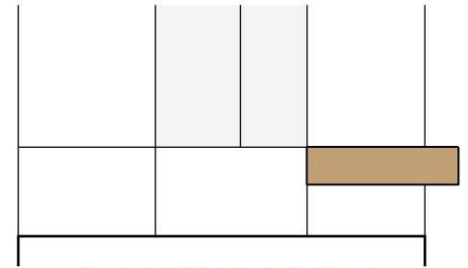

Threshold Visibility Exterior = 0

Threshold Visibility Interior = 1

Threshold Visibility Middle

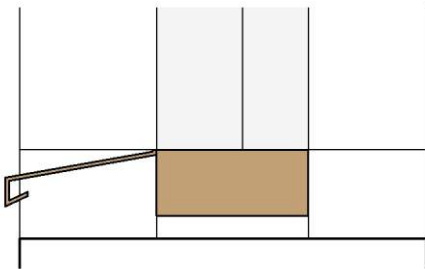

Threshold Visibility Exterior = 3

Threshold Visibility Interior = 0

Threshold Visibility Middle

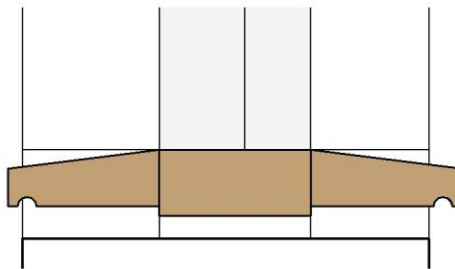

Threshold Visibility Exterior = 2

Threshold Visibility Interior = 2

Threshold Visibility Middle

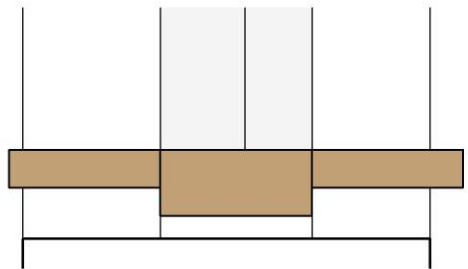

Threshold Visibility Exterior = 1

Threshold Visibility Interior = 1

Threshold Visibility Middle

Threshold Visibility Exterior = 2

Threshold Visibility Interior = 1

Threshold Visibility Middle

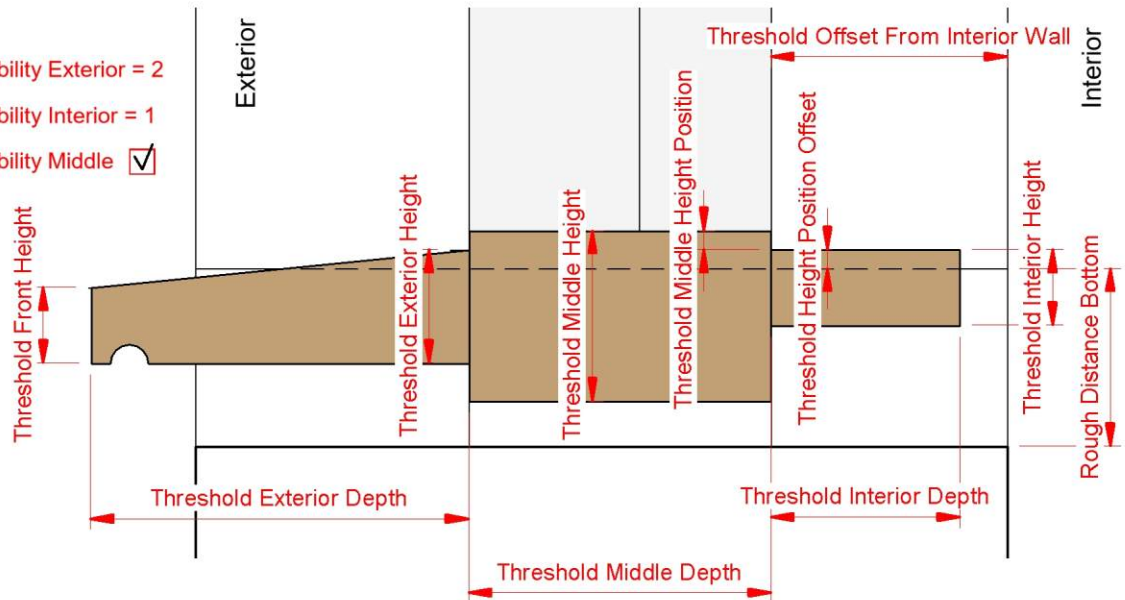

Threshold Offset Left

Threshold Offset Right

